



Main catalogue

Skirting boards,
floor profiles and accessories

Edition 1 | April 2023

Döllken Profiles

SURTECO GROUP

New products

S 60 flex life with short flexible soft lip



More info on page 14

Modern new range: S 60 flex life Top



More info on page 12

Craftsman training at our Event Center



More info on page 18



Cubu life 60 without flexible soft lips

More info on page 25

You can find our wooden mouldings online – Solid wood catalogue

Available in the download area on our website.

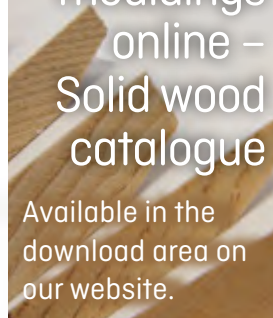

New decors
Cubu flex life Decor +
WASL Design

Page 27 + 136

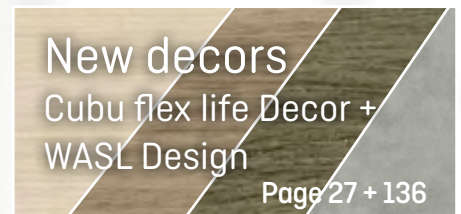

KSO 6



Page 17

More info on page 47



Cubica
Light System 80

Special marker for the Skirting Board Installation



More info on page 126



Notching Pliers



Page 125

Mitre Shears



Page 129

Important changes in the assortment and the latest online version of the catalogue can always be found online on our website doellken-profiles.com

Perfect finishing touch for any floor

As diverse as modern floor coverings are, so are the variants of skirting boards by Döllken Profiles, which ensure a seamless transition between the floor and wall. From solid-core skirting to special profiles, the model is determined by the place of use. Whether a purely plastic-based solution or a high-quality solidcore skirting with HDF core, all products

are developed for and with the customer, perfectly tailored to the requirements of professional floor layers. New, customized collections are regularly developed, adjusted to current trends of existing floors such as LVT, laminate, and textile.

From the floor to the skirting board



Decor expertise is one of the most essential skills of Döllken Profiles, making the company almost unique in the industry. With a pronounced decor expertise, current trends are transformed into successful product solutions. Our decor finder already provides over 5000 skirting board recommendations

for current floor covering collections. For more than 25 years, we have been pursuing innovative ways in processing and product development, with a focus on customer proximity, sustainability, and service orientation.

Looking for the perfect decor to match your flooring?
Then take a look at our decor finder on www.doellken-profiles.com or in the Döllken Profiles App.



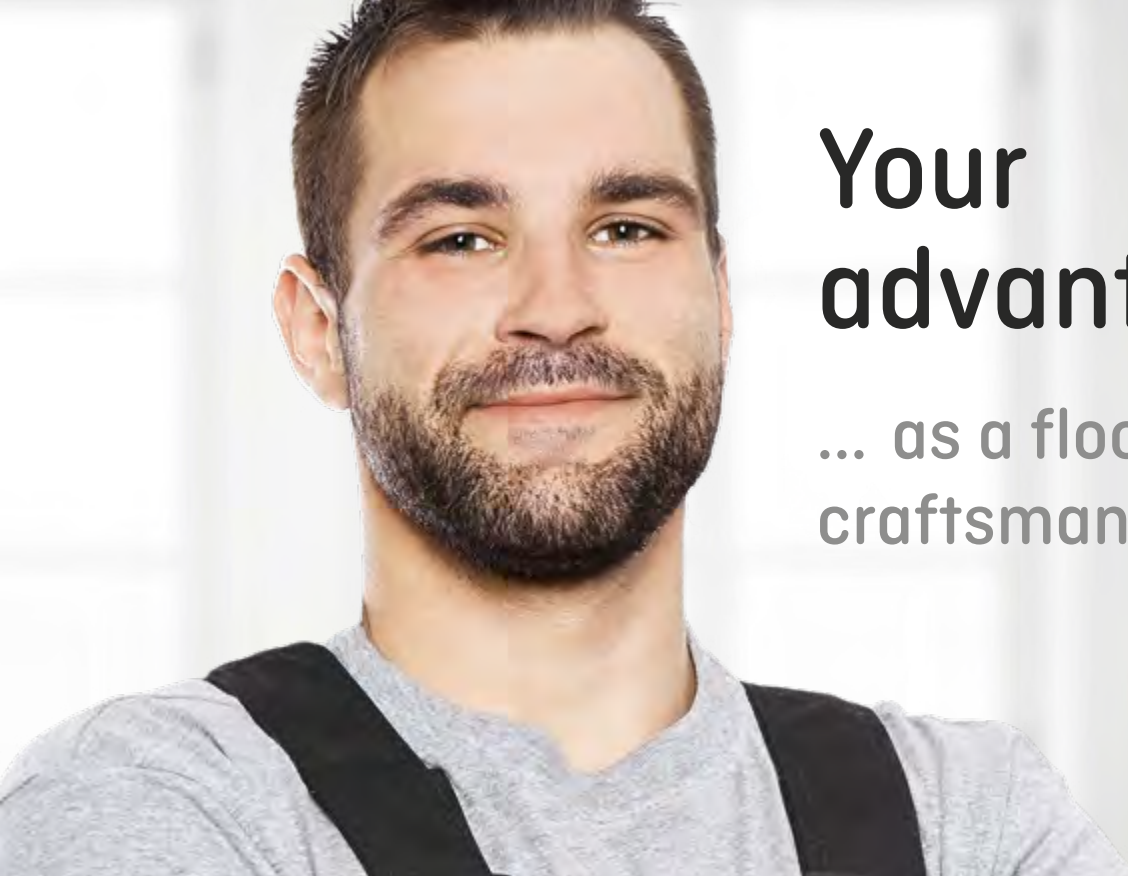

Your advantages

... as a floor-laying craftsman

- Time savings of 30-50% with Döllken tools compared to other tool systems
- Durable products with the highest quality standards
- The decors are aligned with the collections of many well-known flooring manufacturers – new decors are added daily
- Döllken Profiles products have been proven to result in fewer complaints
- Fast availability of all products – express deliveries are also possible
- Almost complete availability due to the cooperation with almost all flooring and paint wholesalers in Germany and Austria

Our services for you:

- Free sample orders for all items
- Free training and workshops
- On-site consultation
- Processing instructions and videos with numerous tips and step-by-step tutorials (www.doellken-profiles.com/en/processing)
- Rental or trial equipment at many retailers
- Repair service online or via the Döllken App
- Express and direct delivery in cooperation with retailers
- Customer-oriented communication: Call us, email us, or use the Döllken Profiles App to get in touch with us

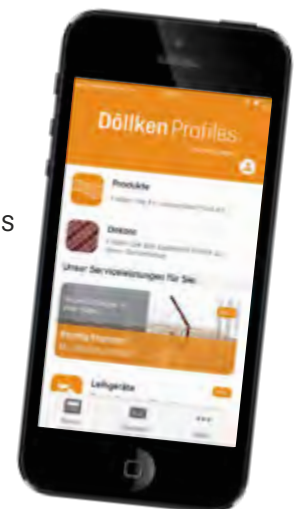

i



Did you know? We offer many tips and tricks on YouTube. Visit us at: www.youtube.com/DöllkenProfilesGmbH



Your advantages

... as a specialist
and wholesale

- Established products in the market
- Regular development of new products
- Fast availability (comprehensive stockholding of all items)
- On request, direct deliveries to your customers
- Free matching of your flooring collections with our skirting boards
- On request, publication of your skirting board assignments in our decor finder
- Free content for your website, catalogs, etc.
- A well-positioned field service to support you
- Support in project business through special productions with small batch sizes
- Support in architect work with corresponding documents and samples

Our services for you:

- Decor finder for quick assignment of suitable skirting boards
- Free sample ordering for all items
- Free training for both the inside and outside sales team
- Discounted rental tools (mitre tool and hot glue gun) with 50% off the list price
- Publication of rental equipment in our app
- Support for your field service through joint visits to your customers
- Regular hosting of events in your location, such as Mitre tool days, Painter breakfasts, etc.
- Publication of your events in our app
- Marketing support for sampling, POS design, webshops, and more.



Visit us on Facebook and Instagram to
get more useful information!

i

Legend

Environmental protection

At Döllken Profiles, environmental protection is a central concern in both the products and the production process.



Greenguard Gold Certification

Nearly all Döllken Profiles products meet the strictest and most comprehensive requirements for reducing emissions of pollutants into indoor air, making them suitable for use in sensitive environments such as schools or healthcare facilities.



Emissions

All solidcore skirting boards have very low emissions. They do not release harmful organic compounds into indoor air.



Blue Angel

NEW

Nearly all solidcore skirting boards are certified with the Blue Angel eco-label.

www.biauer-engel.de/uz176



Additional certifications

All solidcore skirting boards are made of chlorine-free plastic, certified to ISO 16000, and have low emissions.



All plastic skirting boards are produced exclusively with phthalate-free plasticizers.



Upon request our flexible skirting boards are also available as antibacterial versions in accordance with the ISO22196:2011 standard, and are certified with the Biomaster seal.

Icon Legend



Döllken
Mitre Tool



Döllken
Clamping Lever-XL



Döllken
Hot-Melt Glue



Döllken
Strip Cutter



Döllken
Skirting scissors



Döllken
Mitre Shears



Döllken
Easyscooter



Döllken
Notching Pliers



Döllken
Assembly Hammer



Döllken
Fugenfill Set



Döllken
Skirting Board Pins



ClipStar
Metal Type G



UZIN
Tape



Screws



Mitre Saw



Slotted
Screwdriver



Side Cutters or
Electrician's Pliers



Climate-resistant



Quick assembly



Resilient



Water-repellent



Slip-resistant min.
slip resistance
class R 10



Hot air gun



Please note that the decor images and colours may not always correspond one hundred percent to the real decor, and colour deviations may occur. If you would like to have a binding decor in advance, simply use our sample service in our app!

Content

	Page
Solidcore Skirting Boards	
Robust and professional to work with	8-43
LED and Cable Duct Skirting Boards	
Exceptional appearance and functional properties perfectly combined	44 - 51
Plastic Skirting Boards	
Reliable finishing on a variety of floor coverings	52-71
Wall and Special Profiles	
Clean finishes on walls, door frames, or heating pipes	72-87
Flexible Soft Skirting Boards	
Quickly create a harmonious connection between wall and floor	88-99
Flooring Profiles	
The optimal solution for heavily stressed areas	100-115
Tools	
Perfectly tailored to meet current requirements	116-133
Kitchen Profiles	
Clean connection between worktop and wall	134-142
Accessories	
Useful helpers and all-rounders for daily use	143-153

Your contact to our customer service

Wholesale and specialist retail:
+49 3643 4170 711
info@doellken-profiles.com

DIY stores:
+49 2383 910 00 717
kundencenter@praktikus.de

Industry:
+49 2383 910 00 717
info@doellken-profiles.com

Craftsmen and architects:
+49 3643 4170 711
info@doellken-profiles.com

We are here for you! For inquiries outside our business hours, you can also email us your request. We will get back to you as soon as possible.





Solidcore Skirting Boards

Compelling in practical use as well as in ecological balance

The solidcore skirting boards are characterized by the following properties and advantages:

- high-quality cores made of certified softwood fibers
- coated with high-performance polymers
- very robust and durable
- high efficiency during installation, as all solidcore skirting boards are punchable with the Döllken mitre tool

Overview of solidcore skirting boards

(Wholesale | All sales channels)

	Page
EP 60 flex life	11
S 60 flex life Top	12
S 60 flex life with short flexible soft lips	14
Core skirting board 60	15
S 100 life	16
KSO 6	17
Cubu flex life	24
Cubu life 60 without flexible soft lips	25
Cubu flex life Decor	26
Cubu flex life Premium	28
Cubu flex life Stone & Style	29
Cubu flex life Touch & Style 60	30
Cubu flex life XL	32
Cubu flex life XL Touch & Style	33
Hamburg Style	36
D 60 life Top	37
C 60 life Top CV adhesive strip 60	38
TS 60 life Top	40
TS 100 life Top	41
Carpet core skirting board 60	43



Almost all solidcore skirting boards are awarded with the Blue Angel! (excluding Cubu Premium and Cubu Stone & Style).

NEW



EP 60 flex life

Minimum order quantity of 1000 m for a height of 80 mm

Suitable for the following types of flooring

- Solidcore skirting board specifically designed for design flooring

Product information

- HDF core, coated with chlorine-free Polyblend based on PP/TPE, with flexible soft lip at the top and bottom
- Decor matched to the design flooring collections according to composite lists (current lists available on the website)
- The profile ends can be formed from the profile without additional molded parts using the Döllken Profiles mitre tool.



www.blauer-engel.de/uz176

PVC FREE



TCF totally chlorine-free

Processing recommendations



Döllken Mitre Tool



Döllken Hot-Melt Glue



Döllken Skirting scissors (only for EP 60 mm)

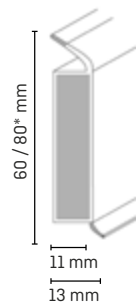

Scan now and check out installation tips!



Wholesale

- 1 sales unit = 10 x 2,5 m
[EP 60 also available in smaller quantities for a surcharge]

*Minimum order quantity of 1000 m for a height of 80 mm.

Colours

- over 300 decor options in the range

(Special colours available upon request)

You can find the entire decor range on our website or in the app.

S 60 flex life Top

Available as short length on request!



Suitable for the following types of flooring

- Solidcore skirting board for all types of flooring

Product information

- HDF core, coated with chlorine-free Polyblend based on PP/TPE, with flexible soft lips at the top and bottom



www.blauer-engel.de/uz176



Processing recommendations



Döllken Mitre Tool



Döllken Hot-Melt Glue



Döllken Notching Pliers



Döllken Skirting scissors



UZIN Tape

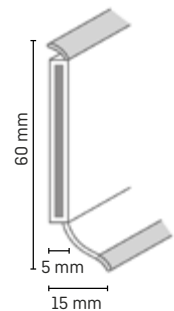

Wholesale

- 1 sales unit = 20 x 5,15 m (on request also available in 20 x 2,57 m)

Accessories

- 1 sales unit = 10 pieces
- available in the following colours: 1013 white, 1147 grey



End caps left/right



Connectors



Modern new range:

- ✓ matched to current flooring decors
- ✓ Expansion of decor printing process as well as the use of new embossings

New stock program

38 new decors & 2 new colours

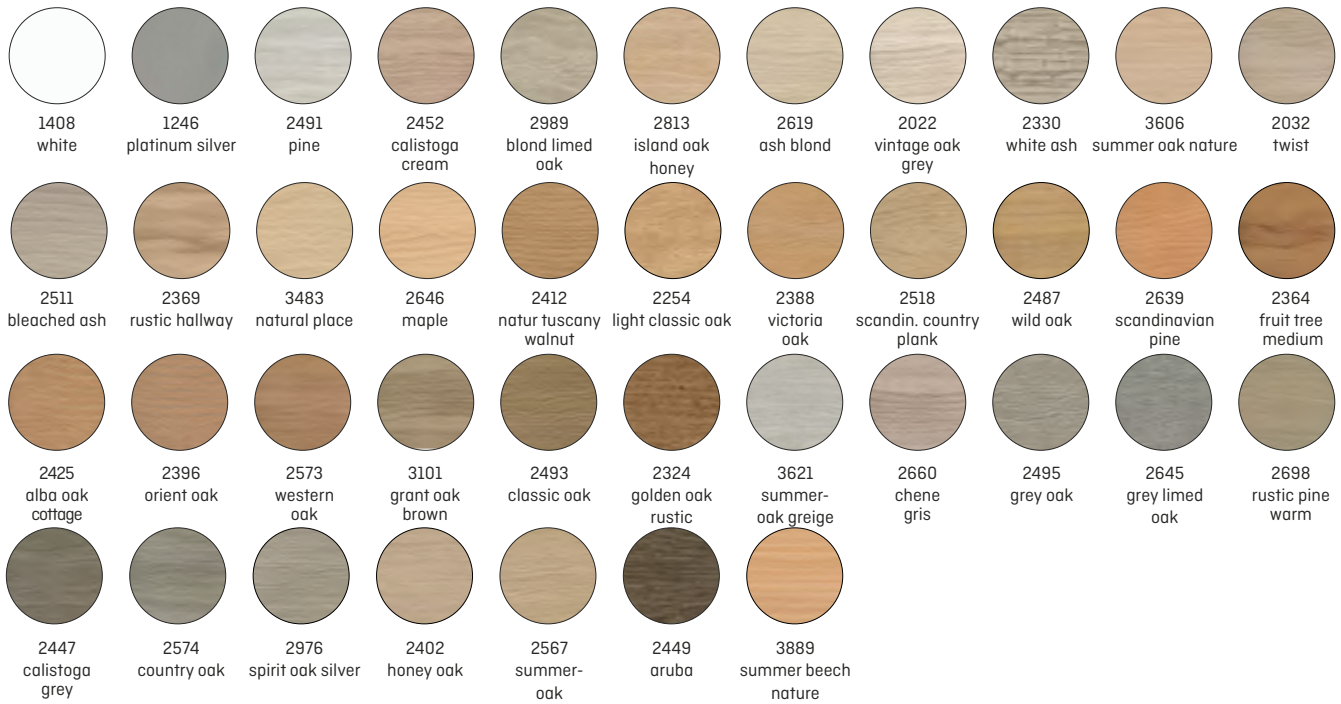

22 popular colours & decors remain in the stock program



23 discontinued decors

Discontinuation starting from 30.06.2023



S 60 flex life with short flexible soft lip



Suitable for the following types of flooring

- Core skirting board suitable for all types of flooring

Product information

- HDF core, coated with chlorine-free polyblend based on PP/TPE, with flexible soft lips at the top and bottom



Processing recommendations



Döllken Mitre Tool



Döllken Hot-Melt Glue



Döllken Notching Pliers



Döllken Skirting scissors



UZIN Tape

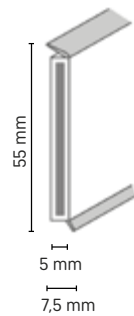

Wholesale

- 1 sales unit = 20 x 5,15 m
(on request also available in 20 x 2.57 m)

Colours

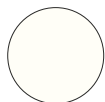

1013 white

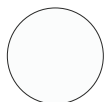

1408 white



1147 grey



1012 light grey



1209 anthracite



1144 black

Core skirting board 60

Also available upon request in a height of 80 mm!
(Minimum order quantity of 1000 m)

Suitable for the following types of flooring

- Core skirting board suitable for all types of flooring

Product information

- HDF core, coated with chlorine-free polyblend based on PP/TPE, with flexible soft lips at the top and bottom



www.blauer-engel.de/uz176

Processing recommendations



Döllken Mitre Tool



Döllken Hot-Melt Glue



Döllken Notching Pliers



Döllken Skirting scissors

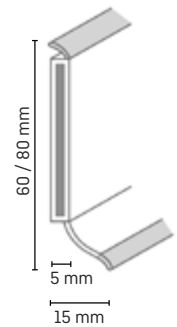

All sales channels

- 1 sales unit = 20 x 2,55 m (60 mm height)
- 1 sales unit = 10 x 2,575 m (80 mm height)

Accessories

Available as:

- SB: 1 sales unit = 5 x 2 pieces
- Bulk back: 1 sales unit = 1 x 50 pieces

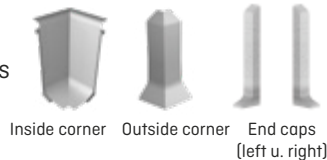

Colour selection für SB packaging:

oak
oak rustic
light grey
white
grey

black
maple
beech
oak beige
beech dunkel

Colour selection for the bulk pack:

oak
white
grey
beech light

Colours Core skirting board 60



Colours Core skirting board 80



S 100 life

Available
as short length
on request!

Suitable for the following types of flooring

- Solidcore skirting for all types of floor coverings

Product information

- HDF core, coated with chlorine-free Polyblend based on PP/TPE, with flexible soft lips at the bottom



www.blauer-engel.de/uz176

PVC
FREE



TCF
totally
chlorine-
free

Processing recommendations



Döllken
Mitre Tool



Döllken
Hot-Melt Glue



Döllken
Notching Pliers



UZIN
Tape

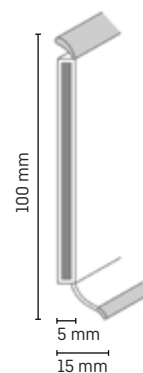

Wholesale

- 1 sales unit = 10 x 5,15 m

Colours

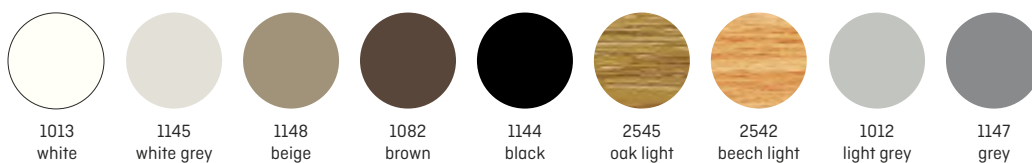

(Special colours are available upon request.)



Scan now and watch processing tips
on our YouTube channel!



Suitable for the following types of flooring

- Solidcore skirting for all types of floor coverings

Product information

- HDF core, coated with chlorine-free Polyblend based on PP/TPE, with flexible soft lips at the bottom



www.blauer-engel.de/uz176

Processing recommendations



Döllken Mitre Tool



Döllken Hot-Melt Glue



Döllken Notching Pliers



Döllken Skirting scissors

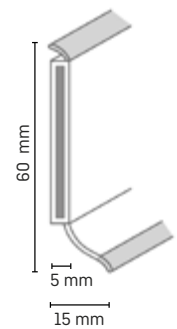

Wholesale

- 1 sales unit = 20 x 5,15 m

Accessories

- Bulk pack: 1 sales unit = 1 x 50 pieces

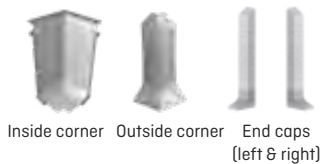

Colour selection for the bulk pack:
oak, white, grey, beech light

Colours



All sales channels

- 1 sales unit = 20 x 2,575 m

Accessories

- SB: 1 sales unit = 5 x 2 pieces



Colour selection für SB-packaging:
oak
oak rustic
light grey
white
grey
black
maple
beech
oak beige
beech dark

Colours

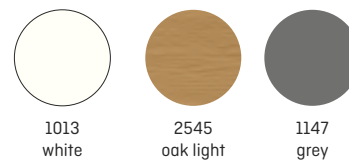

Craftsman training at our Event Center

By professionals, for professionals

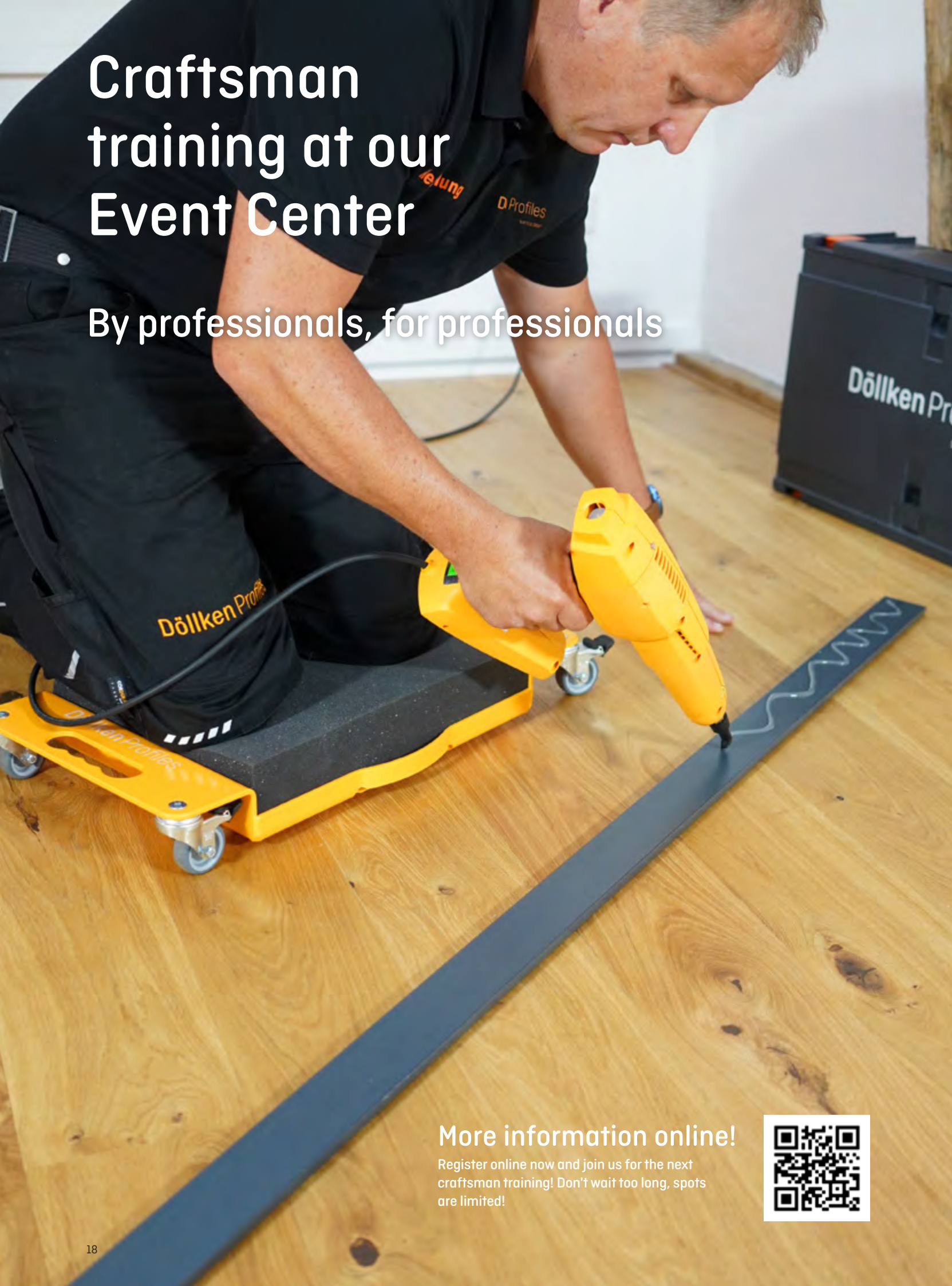

More information online!

Register online now and join us for the next craftsman training! Don't wait too long, spots are limited!



You can expect 2 full days of professional knowledge on the subject of skirting board installation for a contribution of only 100 €*.

*per person plus value-added tax (VAT). The following services are included: hotel, meals, entertainment, tool voucher, plus your own travel expenses. For events without overnight stay, the amount will be held as a deposit and refunded after attendance. If you do not attend or cancel within 4 weeks before the event, the amount will be retained.

Our Event Center is located in an idyllic location close to the metropolitan region of Dortmund.



Drei-Eichen-Weg 5
59069 Hamm



Event Center in Hamm

Theory & practice:
Punching, gluing, and installing skirting boards - practical exercises for each participant with valuable tips & tricks from our application technicians, as well as presentation of our product innovations.



Workshops / Training sessions

Behind the scenes:
Factory tour at skirting board manufacturer Döllken Profiles in Bönen with exciting insights.

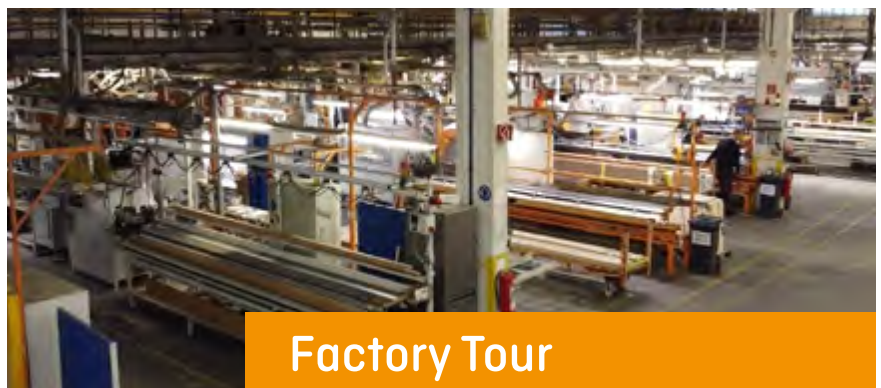

Factory Tour

We organize a suitable entertainment program (e.g. stadium tour at BVB) with meals and hotel accommodation. Additionally, there are exclusive promotions such as mitre tool maintenance and vouchers or discounts for Döllken tools.

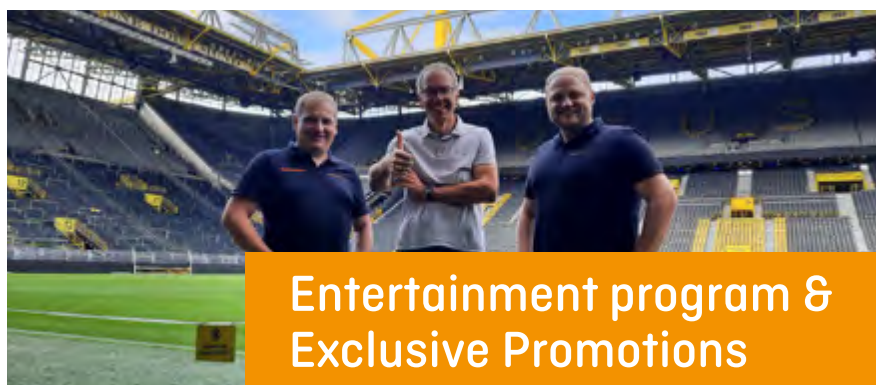

Entertainment program & Exclusive Promotions

The Diversity of the Cubu Family

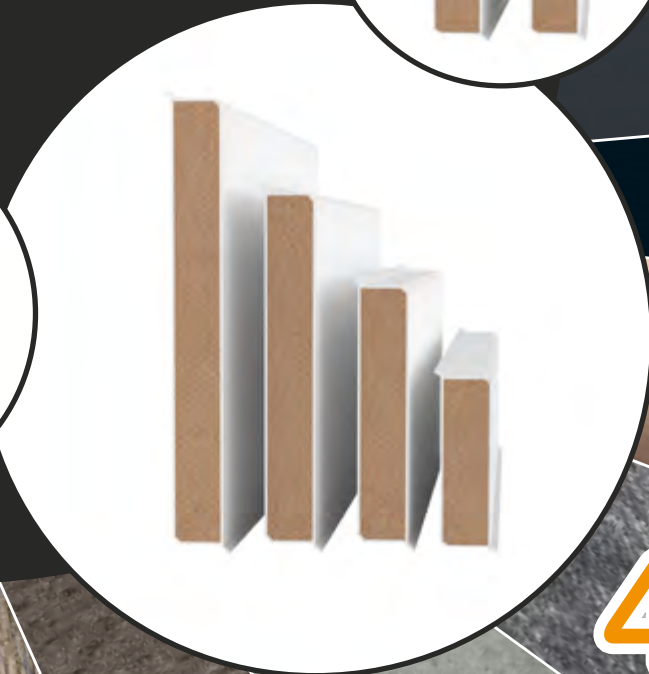

2 Thicknesses

2 Shapes

4 Heights

5 Surface Types

Versatile and Individually combinable: The Choice is Yours.

Now, upon request, you can put together your own custom Cubu!



All solid core skirting boards marked with this label in the catalogue can be combined upon request.



..... 11 and 16 mm solidcore (covering 13mm and 18mm respectively)

..... Cubic and Hamburg style

..... 40, 60, 80, 100 mm

..... Solid-coloured plastic surfaces, haptic plastic films, chlorine-free plastic films, melamine films, real metal films.

The Cubu Family

Advantages at a glance

- ✓ Punchable: Closed corners, no visual breaks from open cut edges, no need for silicone or additional molded parts
- ✓ Durable and robust against impacts, dirt, and moisture
- ✓ Efficient to work with, quick and uncomplicated installation
- ✓ Water-resistant plastic coating





www.blauer-engel.de/uz176



GreenGuard certified:
can be used without concern in sensitive environments, such as schools or healthcare facilities.

Almost all solidcore skirting boards* are awarded the "Blue Angel" certification: meaning that the wood in the core comes from sustainable forestry to preserve our nature, and in addition, the skirting boards are low-emission and low in harmful substances, making them safe for human health.

Healthy living environment: With our PVC-free Cubu skirting boards, you can be assured that your home remains free of harmful substances.

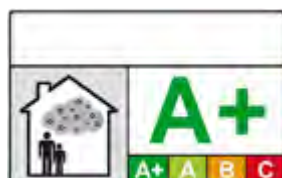

*except Cubu Premium and Cubu Stone & Style



Suitable for the following types of flooring

- Solidcore skirting for all types of flooring

Product information

- HDF core, coated with chlorine-free Polyblend based on PP/TPE, with flexible soft lips at the top and bottom
- The profile ends can be formed without additional molded parts using the Döllken mitre tool



www.blauer-engel.de/uz176

Processing recommendations



Döllken Mitre Tool



Döllken Hot-Melt Glue



Döllken Fugenfill Set



Döllken Skirting scissors (only for Cubu 60 mm)

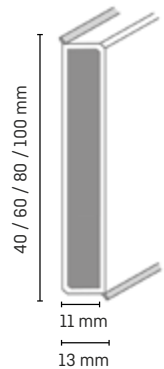

All sales channels

- 1 sales unit = 10 x 2,5 m

Accessories

- 1 sales unit = 5 x 2 pieces



Corner blocks as inside and outside corner

Colour selection
1013 white
1063 silver

Scan now and watch processing tips on our YouTube channel!



Colours

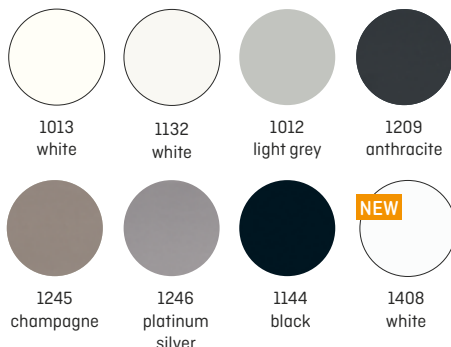

[Special colours available upon request]

Four different heights – available colours:

Cubu flex life	40 mm	60 mm	80 mm	100 mm
1013 white	✓	✓	✓	✓
1132 white	✓	✓	✓	✓
1408 white	-	✓	✓	-
1012 light grey	✓	✓	✓	✓
1209 anthracite	✓	✓	✓	✓
1245 champagne	✓	✓	✓	✓
1246 platinum silver	✓	✓	✓	-
1144 black	-	✓	✓	✓

Cubu life 60

NEW

without flexible soft lips

Suitable for the following types of flooring

- Solidcore skirting for all types of flooring

Product information

- HDF core, coated with chlorine-free Polyblend based on PP/TPE, with flexible soft lips at the top and bottom
- Solidcore skirting without soft lips, allowing for individual repairs with silicone at the transition between skirting, floor and wall in the case of strong wall and floor irregularities, particularly suitable for use in older buildings
- Proven advantages of the Cubu series: resistant to moisture, dirt, and shocks
- The profile ends can be formed without additional molded parts using the Döllken mitre tool

Processing recommendations



Döllken
Mitre Tool



Döllken
Hot-Melt Glue



Döllken
Fugenfil-Set



Döllken
Skirting scissors

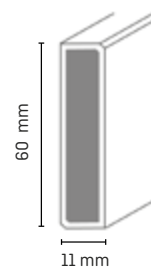

www.blauer-engel.de/uz176

All sales channels

- 1 sales unit = 10 x 2,5 m

Colours

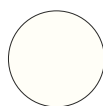

1013
white

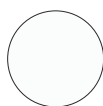

1408
white

Accessories

- 1 sales unit = 5 x 2 pieces



Colour selection
1013 white

Corner blocks
as inside and
outside corner

Cubu flex life Decor

New
decors



Suitable for the following types of flooring

- Solidcore skirting for all types of flooring

Product information

- HDF core, coated with chlorine-free Polyblend based on PP/TPE with flexible soft lips on the bottom and top
- Continuous design, including printed soft lips
- Decors are coordinated with many common design flooring
- Profile ends can be formed from the profile without additional molded parts using the Döllken Profiles mitre tool

Processing recommendations



Döllken
Mitre Tool



Döllken
Hot-Melt Glue



Döllken
Skirting scissors

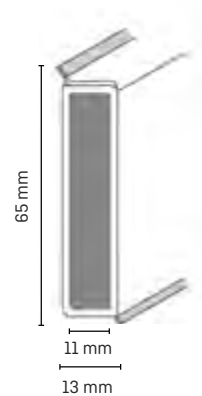

All sales channels

- 1 sales unit = 10 x 2,5 m

Colours (Auswahl von über 300 Dekoren)

1013 white	2033 calypso	2032 twist	2386 malua	2486 smoked oak	2572 fashion oak	2574 country oak	2580 grey cherry	2339 oak classic	2407 european oak	2022 vintage oak grey
2258 limed grey wood	2324 golden oak rustic	2332 oak waxed	2357 plank country	2365 oak light	2369 rustic hallway	2428 alder	2370 silver oak	2373 silver slate	2375 oak vintage	2379 driftwood grey
2388 victoria oak	2402 honey oak	2424 honey oak	2445 monterey cream	2485 s. oak white	2487 wild oak	2491 pine white	2562 pine white	2570 native oak	2571 vintage desert	2603 classic oak
2615 sandstone grey	2629 alba oak snow	2661 chene naturel	1144 black							





























(Special colours available upon request)

Experience a perfectly harmonious connection between skirting board and your desired design flooring with our continuously printed design strip. The printed soft lips provide an appealing and uniform appearance in your rooms.



www.blauer-engel.de/uz176



- | | | | | | | | | | | |
|---|---|---|---|--|---|---|---|---|--|--|
| 
2003
nordic ash | 
2004
classic oak dark | 
2015
filler eff light | 
2368
sandstone nature | 
2391
cambridge | 
2396
oak orient | 
2447
calistoga grey | 
2452
calistoga cream | 
2494
ash blond | 
2495
oak grey | 
2568
oak rustic |
| 
2698
rustic pine warm | 
2573
western oak | 
2589
royal oak | 
2719
iceland | 
2773
plank-wood | 
2813
island oak honey | 
2986
white ash | 
3058
cc67523 | 
3096
lunar greige | 
3101
grant oak brown | 
3483
natural place |
| 
3594
sherman oak | 
3595
kentucky oak | 
3600
sebastian oak | 
3604
texas oak | 
3620
oak sheffield braun | 
3776
sommer oak | | | | | |

Over 300 additional decors in our product range - available on request!



Cubu flex life Premium

Also available in 80 mm height!*



Suitable for the following types of flooring

- Solidcore skirting with genuine metal finish, making it an excellent design element for sophisticated floor design

Product information

- HDF core, coated with chlorine-free Polyblend based on PP/TPE, with flexible soft lips on the top and bottom
- Finished with a genuine metal foil
- Flexible wall and floor lips adapt to the unevenness of the respective surface
- Profile ends, as well as inner and outer corners, can be formed from the profile without additional molded parts using the Döllken Profiles mitre tool

Processing recommendations



Döllken Mitre Tool



Döllken Hot-Melt Glue



Döllken Skirting scissors (only for Cubu 60 mm)



Hot air gun

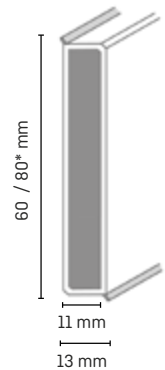

All sales channels

- 1 sales unit = 10 x 2,5 m (height of 60 mm also available in smaller quantities for a surcharge)

Colours



1190* stainless steel



1193 copper light

i
* The height of 80mm is only available for decor 1190 (stainless steel)!

[Special colours available upon request]

Pro tip: Warm up the punched-out area with a heat gun, and the special genuine metal foil can easily be formed around the outer corner without any difficulties.



Scan QR code now and watch the video!



Suitable for the following types of floor coverings

- Solidcore skirting specially designed for floor coverings with stone and concrete looks

Product information

- HDF core, coated with chlorine-free Polyblend based on PP/TPE, with flexible soft lips at the top and bottom
- The profile ends, as well as the inner and outer corners, can be formed from the profile without additional moldings using the Döllken mitre tool
- Durable and resistant to climatic changes
- Trendy stone and concrete looks

Processing recommendations



Döllken
Mitre Tool



Döllken
Hot-Melt Glue



Döllken
Skirting scissors

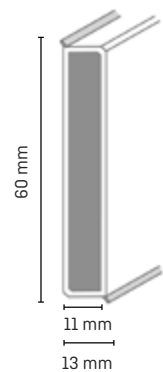

All sales channels

- 1 sales unit = 10 x 2,5 m (height of 60mm also available in smaller quantities for a surcharge)

Colours

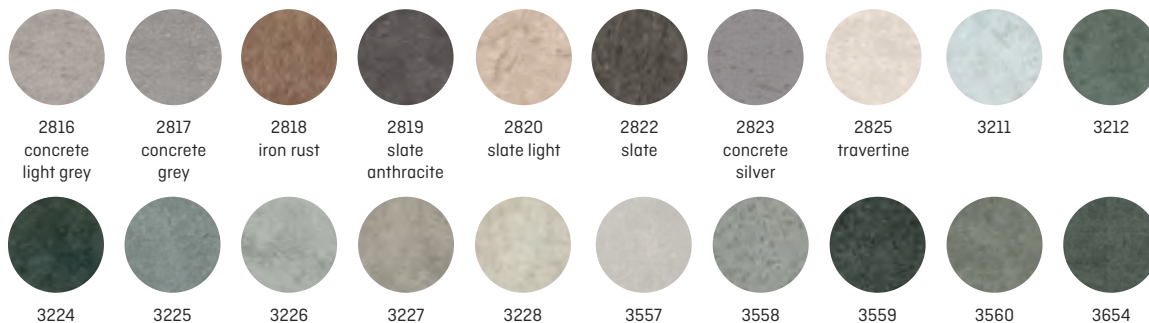

[Special colours available upon request]

Pro tip:

For optimal support of the solidcore skirting, we recommend using the trestles that come with the mitre tool. You can find them on page 119.



Cubu flex life Touch & Style 60

Mimics the natural look and feel of the real surface



Suitable for the following types of flooring

- Solidcore skirting with three-dimensional printed foil for laminate flooring

Product information

- HDF core, covered with chlorine-free polyblend based on PP/TPE, with flexible soft lips on the top and bottom
- The profile ends as well as internal and external corners can be formed from the profile without additional fittings using the Döllken Profiles mitre tool
- Natural look with a special texture, achieved through the three-dimensional embossed foil in true-to-life decors

Processing recommendations



Döllken Mitre Tool



Döllken Hot-Melt Glue



Döllken Skirting scissors

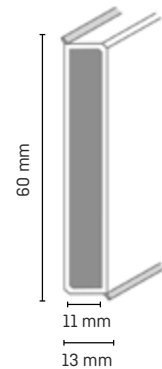

All sales channels

- 1 sales unit = 10 x 2,5 m
[height of 60 mm also available in smaller quantities for a surcharge]

Colours

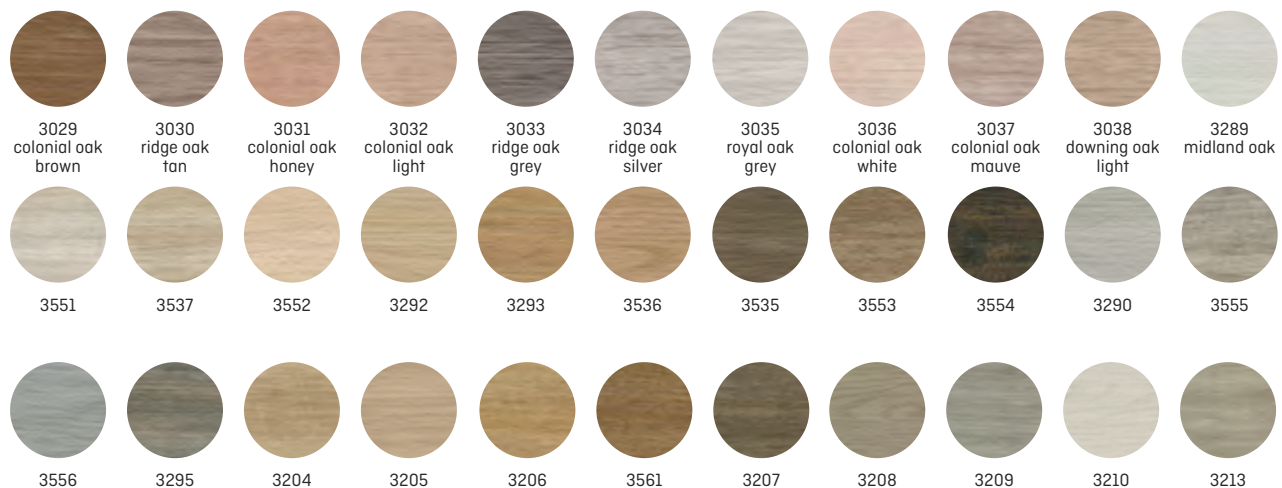



(Special colours available upon request)





Suitable for the following types of flooring

- Cube profile for all types of flooring, particularly for covering expansion joints when used with laminate flooring

Product information

- HDF core, covered with chlorine-free polyblend based on PP/TPE, with flexible soft lips on the top and bottom
- The profile ends as well as internal and external corners can be formed from the profile without additional fittings using the Döllken Profiles mitre tool
- More flexibility in covering expansion joints up to 18 mm, particularly when used with laminate flooring

Processing recommendations

- Döllken Mitre Tool
- Döllken Clamping Lever-XL für Mitre Tool
- Döllken Hot-Melt Glue
- Döllken Fugenfil Set

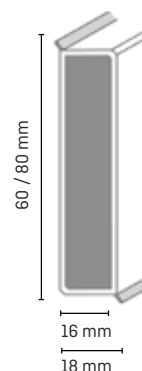

www.blauer-engel.de/uz176

All sales channels

- 1 sales unit = 6 x 2,5 m [Cubu XL mit 80 mm height]
- 1 sales unit = 8 x 2,5 m [Cubu XL mit 60 mm height]

Accessories

- 1 sales unit = 5 x 2 pieces



Corner blocks as inside and outside corner

Colour selection 1013 white

Scan now for processing tips



Pro tip:

For optimal support of the solidcore skirting, we recommend using the trestles that come with the mitre tool. You can find them on page 119.



Colours

- 1013 white
- 1132 white
- 1012 light grey
- 1408 white

(Special colours available upon request)

Two different heights - available colours:

Cubu flex life XL	60 mm	80 mm
1013 white	✓	✓
1132 white	✓	✓
1012 light grey	-	✓
1408 white	✓	✓

Cubu flex life XL Touch & Style

Mimics the natural look and feel of the real surface



Suitable for the following types of flooring

- Solidcore skirting with a three-dimensional printed foil for laminate flooring

Product information

- HDF core, covered with chlorine-free polyblend based on PP/TPE, with flexible soft lips on the top and bottom
- The profile ends as well as internal and external corners can be formed from the profile without additional fittings using the Döllken Profiles mitre tool
- Natural look with a unique texture, created by the three-dimensional embossed foil in realistic designs.
- Highly recommended for use with laminate flooring
- Extra thick profile for large expansion joints

Processing recommendations



Döllken Mitre Tool



Döllken Clamping Lever-XL for Mitre Tool



Döllken Hot-Melt Glue

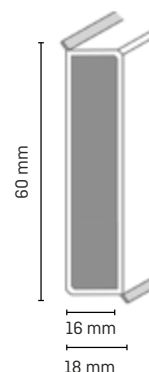

All sales channels

- 1 sales unit = 8 x 2,5 m (also available in smaller quantities for a surcharge)

Colours

2959 puccini	2958 andersen	2962 tojet	2943 tamija	2961 canvas	2960 zonda	2935 morisette	2934 melua	2936 tibidabo	2938 sobrine	2939 edeline
2937 mabelle	2947 ligna	2949 aralie	2948 leander	2950 paulin	2951 careen	2941 racine	2940 takoua	2942 madelon	2945 regine	2944 maelle
2946 clooney	2955 safa	2954 nitens	2957 gauguin	2956 adalie	2953 rachel	2952 tindari	NEW 3060 comfort oak mellow	NEW 3061 memory oak silver	NEW 3141 joy oak tender	NEW 3142 arizona rustic oak

[Special colours available upon request]

Les Couleurs® Le Corbusier®

63 Originals
Les Couleurs®
Le Corbusier®
Colours on
skirting boards

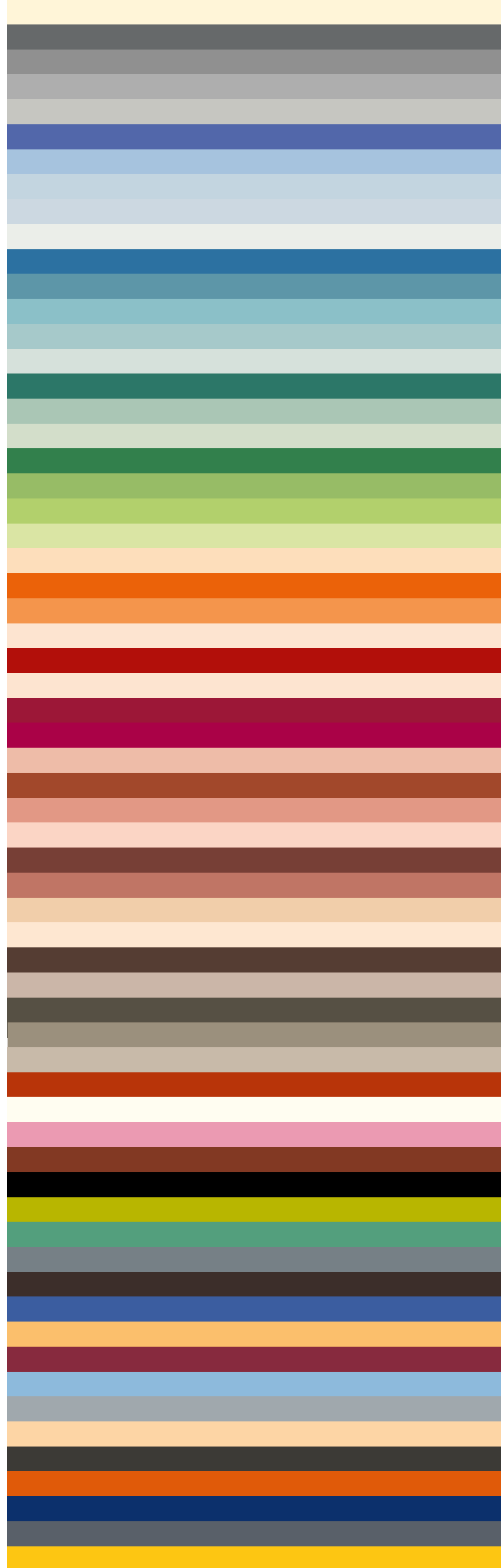
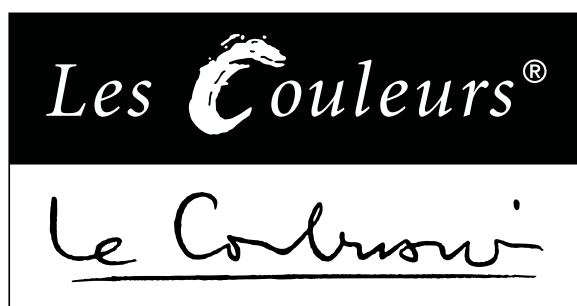

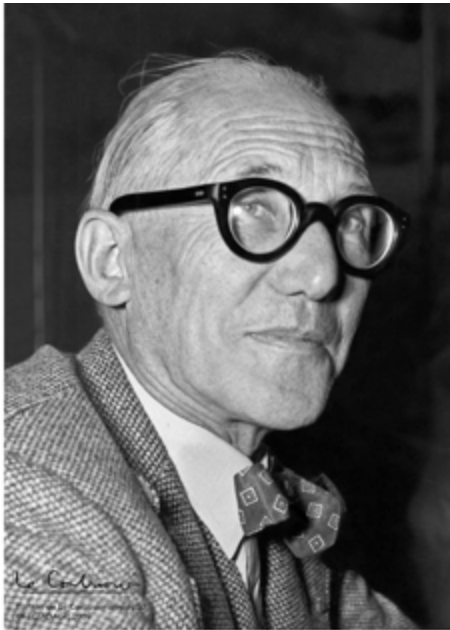

© FLC/ADAGP

Le Corbusier's colour selection was purely subjective. Based on his own cosmos, he chose hues of colour from nature and those with historical, artistic, and associative backgrounds. Perhaps this subjectivity of a genius mind makes the aesthetics of the two collections so unique, which even after many decades, have not lost their grace, energy, and presence. All colours of the colour keyboards can be combined harmoniously with each other. Therefore, the "Polychromie architecturale" is a practical tool and a work of art for many architects and designers alike.

The special thing about the Les Couleurs® Le Corbusier colour system of the world-famous pioneer of modern architecture Le Corbusier is that each of the 63 colours can be combined with any other colour in the system.

Decors and
delivery times
are available on
request.

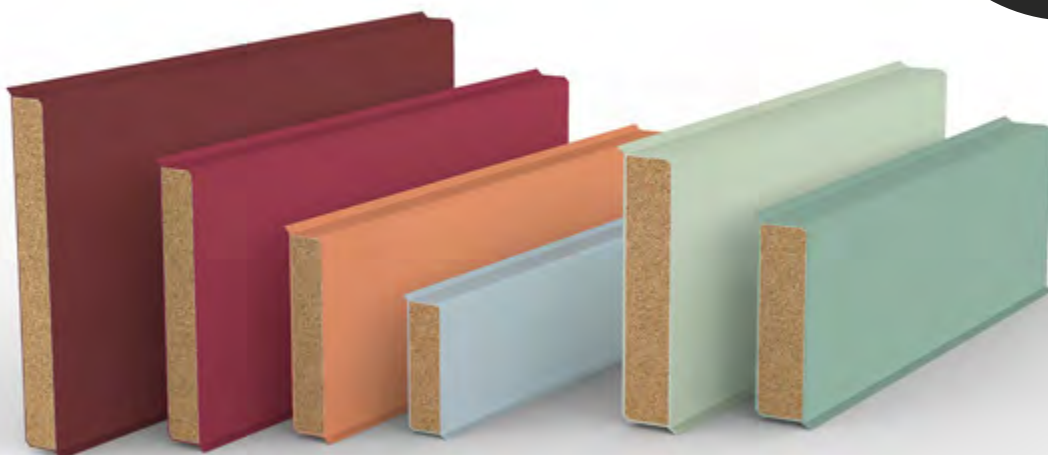

Hamburg Style



Suitable for the following types of flooring

- Solidcore skirting in a classic style for wood or laminate flooring

Product information

- HDF core, coated with chlorine-free Polyblend based on PP/TPE, with flexible soft lips on top and bottom
- The profile ends as well as inner and outer corners can be formed from the profile without additional molding parts using the Döllken Profiles mitre tool
- Durable and resistant to climatic changes
- Classic, timeless design for universal use

Processing recommendations



Döllken Mitre Tool



Döllken Clamping Lever-XL for the Mitre Tool



Döllken Hot-Melt Glue



Döllken Fugenfill

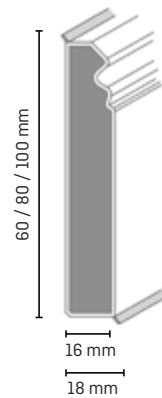

www.blauer-engel.de/uz176

All sales channels

- 1 sales unit = 8 x 2,5 m (Hamburg Style in 60 mm height)
- 1 sales unit = 6 x 2,5 m (Hamburg Style in 80 mm height)
- 1 sales unit = 7 x 2,5 m (Hamburg Style in 100 mm height)

Pro tip:

For optimal support of the solidcore skirting, we recommend using the trestles that come with the mitre tool. You can find them on page 119.



Colours

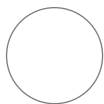

1013 white



1144 black



1408 white

(Special colours available upon request)

Three different heights - available colours:

Hamburg Style	60 mm	80 mm	100 mm
1013 white	✓	✓	✓
1408 white	✓	✓	-
1144 black	✓	✓	-

D 60 life Top

Only in 5,15 m - version available!

i
Now also available without a flexible soft lip!

Suitable for the following types of flooring

- Solidcore skirting specifically designed for gluing in floor strips

Product information

- HDF core, coated with chlorine-free polyblend based on PP/TPE, with flexible bottom lip
- Suitable for gluing in floor strips with a thickness of 4.5 mm
- The design floor strips can also be punched with pressing inserts for the 2001 mitre tool.

Processing recommendations



Döllken Mitre Tool



Döllken Hot-Melt Glue



Döllken Skirting scissors



Döllken Strip Cutter



Klebeband UZIN



Döllken Notching Pliers

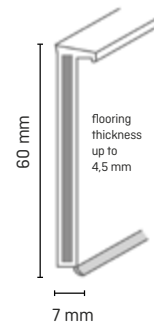

D 60

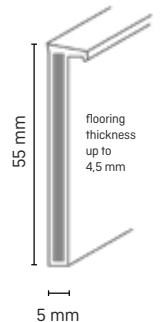

D 60 (without a flexible soft lip)



www.blauer-engel.de/uz176

Wholesale

- 1 sales unit = 20 x 5,15 m

Accessories

End caps:

- 1 sales unit = 10 pieces



End caps left/right

Colour selection 1013 white



Pressing inserts

Pressing inserts:

- 1 sales unit = 1 Set (2 pieces)



Pro Tip:
The design flooring strips can also be punched using the pressing inserts for mitre tool 2001 and can be cut to size with the flexible strip cutter.

Colours D60



[Special colours available upon request]

Colours (D60 without flexible soft lip)



C 60 life Top | CV adhesive strip 60

Also available in 100 mm height! (upon request)



Suitable for the following types of flooring

- Solidcore skirting designed for the adhesive installation of flooring strips

Product information

- HDF core, coated with chlorine-free Polyblend based on PP/TPE, with flexible floor lip
- for adhesive installation of flooring strips
- suitable for a flooring thickness of 4.5 mm
- design flooring strips can also be punched using pressing inserts for the 2001 mitre tool

Processing recommendations



Döllken Mitre Tool



Döllken Hot-Melt Glue



Döllken Skirting scissors



Döllken Strip Cutter



Klebeband UZIN



Döllken Notching Pliers

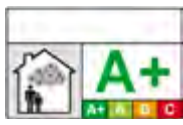
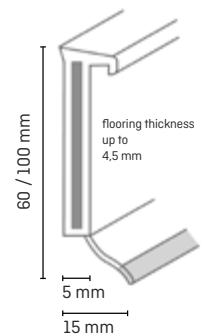

www.blauer-engel.de/uz176

Wholesale

- 1 sales unit = 20 x 5,15 m

Accessories



Pressing inserts:
1 sales unit = 1 set (2 pieces)

Pressing inserts

Colours

1013 white	1147 grey	1159 goldmetallic	1168 alu-metallic	1008 light brown
1086 light beige	1087 brown	1010 cappuccino	1091 chocolate brown	1144 black
1245 champagne	1246 platinum silver	1209 anthracite	1244 stone grey	1064 silver grey

[Special colours available upon request]

All sales channels

- 1 sales unit = 20 x 2,55 m

Accessories



Pressing inserts:
1 sales unit = 1 set (2 pieces)

Pressing inserts

Colours

1013 white	1168 alu-metallic	1159 gold-metallic	1010 cappuccino



Pro Tip:
The design flooring strips can also be punched using the pressing inserts for mitre tool 2001 and can be cut to size with the flexible strip cutter.



Show us your skirting boards!

Have you installed our skirting board in a great project?
Send us photos or videos of your work!

Simply get in touch with us through our social media channels or send us an email to:
[marketing@doellken-profiles.com!](mailto:marketing@doellken-profiles.com)

 [@doellkenprofiles_de](https://www.instagram.com/doellkenprofiles_de)

 [facebook.com/doellkenprofiles](https://www.facebook.com/doellkenprofiles)

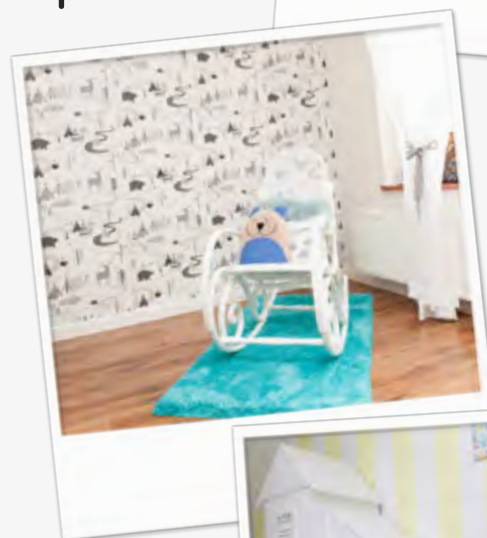

TS 60 life Top

Only available in 5,15m length!

Suitable for the following types of flooring

- Solidcore skirting for carpets

Product information

- HDF core, coated with chlorine-free Polyblend based on PP/TPE, with cable duct
- for adhesive installation of carpet strips
- also available in special production without adhesive strips for carpets with PVC backing containing plasticizers: minimum order quantity upon request!



www.blauer-engel.de/uz176

Processing recommendations



Döllken Mitre Tool



Döllken Hot-Melt Glue



Döllken Notching Pliers



Klebeband UZIN



Döllken Skirting scissors



Döllken Mitre Shears

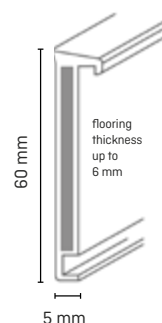

Wholesale

- 1 sales unit = 20 x 5,15 m

Accessories

End caps:

- 1 sales unit = 10 pieces



Colour selection
1013 white

End caps
left/right

Pro tip:

Also, please refer to the installation instructions and videos on our website www.doellken-profiles.com, on the Döllken App, or on YouTube.



Colours

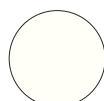

1013 white



1145 white grey

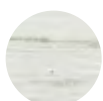

2551 wood white



2549 wood grey



1012 light grey



1152 silver metallic



1147 grey



2545 oak light



2543 beech



1082 brown



1144 black



1246 platinum silver



1245 champagne



1209 anthracite

(Special colours available upon request)

TS 100 life Top

Only available
in 5,15m
length!

Suitable for the following types of flooring

- Solidcore skirting for carpets

Product information

- HDF core, coated with chlorine-free Polyblend based on PP/TPE, with cable duct
- for adhesive installation of carpet strips



www.blauer-engel.de/uz176

Processing recommendations



Döllken
Mitre Tool



Döllken
Hot-Melt Glue



Klebeband
UZIN

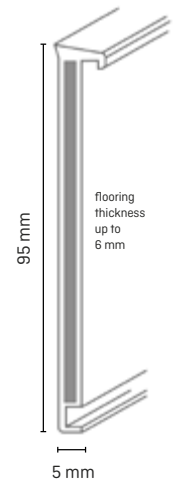

Wholesale

- 1 sales unit = 10 x 5,15 m

Pro tip:

Also, please refer to the installation instructions and videos on our website www.doellken-profiles.com, on the Döllken App, or on YouTube.



Colours



1013
white



1147
grey

(Special colours available upon request)

Our Mobile Customer Service

- Sample service*
- Decor finder
- Repair service*
- Rental service*
- Event search*
- Adhesive calculator

More information online:
doellken-profiles.com/en/service/app



*Registration required (free)



1 Choose the appropriate product

3 Make use of your newly gained time

2 Order samples

Carpet core skirting board 60



Suitable for the following types of flooring

- Core skirting board for carpet

Product information

- HDF core, coated with chlorine-free polyblend based on PP/TPE, with cable channel
- for gluing carpet strips
- protects the carpet edge from fraying



www.blauer-engel.de/uz176

Processing recommendations



Döllken Mitre Tool



Döllken Hot-Melt Glue



Döllken Skirting scissors



Döllken Mitre Shears

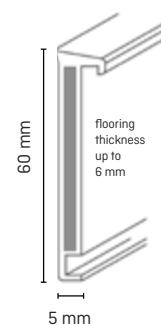

All sales channels

- 1 sales unit = 20 x 2,55 m

Pro tip:

Also, please refer to the installation instructions and videos on our website www.doellken-profiles.com, on the Döllken App, or on YouTube.



Colours



[Special colours available on request]



LED- and Cable Channel Skirting Boards

Exceptional appearance and functional properties perfectly combined

The LED and cable channel skirting boards are characterized by the following features and advantages:

- exceptional appearance
- practical cable channels and detachable/replaceable decorative profiles for functional properties
- invisible mounting systems
- new tactile surfaces for enhanced decorative brilliance

Overview LED- and Cable Channel Skirting Boards

(Wholesale | All sales channels)

Page

Cubica Light System 80	47
System MD 63	48
System SL 48	49
SLK 50 Plastic skirting boards Classic 50	50
SLK 60 „Q“ Cable channel skirting board Cubica 60 sk	51

Cubica Light System

A professional solution that is easy to install

2 lighting variations + 4 decor options = perfectly staged lighting ambiance

Whether as a light accent for a cozy atmosphere in your own four walls or as a safety solution for hotels, ships, or health-care facilities, the Cubica Light System is the highest quality and most flexible lighting solution on the market.



Quick and easy to install with the starter sets



Plug & Play
Connect and turn on the lights!



In addition to the standard package, we also offer to assist and pre-assemble individual projects!

- High-quality LED strip with even light distribution, without visible light spots
- Individually shortenable every 5 cm to the desired length
- Easy installation without additional tools or prior knowledge
- Can be used as a cable channel skirting board or as a combined light and cable channel skirting board
- Pre-made starter and control sets with all necessary components or individual project customization possible (preparation of all required lengths and components through our product configurator)

Get started right away and configure:



Cubica Light System 80

NEW



Now with the new notching pliers (p.117), cut cable exits in seconds!



More information and tips on processing at:
www.cubica-light.de

Suitable for the following types of flooring

- Combined light/cable channel suitable for all types of floor coverings

Product information Cubica Light System

- Two-part channel: base and cover profile* made of Polyblend based on PVC, with flexible soft lips at the bottom and top (cover profile can be clicked on)
- Matching accessories available
- High-quality LED strip simply adhesive (self-adhesive, can be cut every 5 cm, even light distribution, included in separate starter set)
- Combine with Cubu flex life XL 80 (same decor and geometry)

Also available:

- Starter set: Suitable for 5 m LED strip, (A) extension cable, (B) connector (LED strip to cable), (C) connector (LED strip to LED strip), (D) LED connection cable, (E) Y-distribution cable, (F) power supply (transformer for 230 V socket), (G) LED strip
- Control set (H) radio socket and (I) radio switch

*Base profile, cover profile, starter set, and additional control set must be ordered separately

Processing recommendations



Mitre Saw



Skirting scissors



Screws



Döllen Heißschmelzklebesystem



Slotted Screwdriver



Side Cutters or Electrician's Pliers

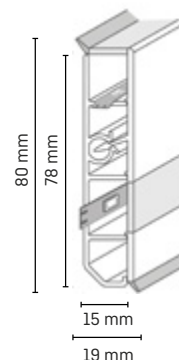

LED strip placable on top (lights up) or bottom (lights down)

Starter set components



Controlset

All sales channels

- 1 sales unit = 10 x 2,5 m (Base profile) *[also available in smaller quantities for a surcharge]*
- 1 sales unit = 10 x 2,5 m (Decor profile) *[also available in smaller quantities for a surcharge]*

Available in three different versions:



No light (without light-cable duct strip)



Light down



Light up

Accessories

- 1 sales unit = 5 x 1 piece (Inside- u. Outside corners, Connectors)
- 1 sales unit = 5 x 2 Stk (End caps)



Inside corner



Outside corner



Connectors



End caps (left and right)

Colour selection
1207 white
1160 aluminium
1245 champagne
1209 anthracite

Colours

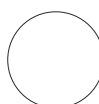

1207 white



1160 aluminium



1245 champagne



1209 anthracite

{Special colours available upon request}

System MD 63



Suitable for the following types of flooring

- System baseboard specifically designed for laminate floors, hard flooring, and elastic flooring

Product information

- 63 mm high profile - particularly suitable for renovations
- Consists of decor profile MD 63 and base profile GP 20 made of chlorine-free polyblend based on PS or PP, with a large cable channel
- Clean floor and wall finish thanks to flexible soft lips at the top and bottom

Processing recommendations



Döllken Hot-Melt Glue



UZIN Tape



Döllken Skirting scissors



Döllken Notching Pliers

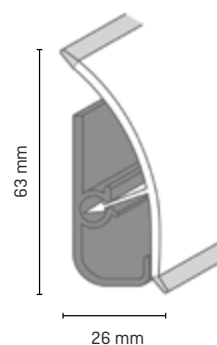

- The base profile must be ordered separately.

All sales channels

- 1 sales unit = 20 x 2,50 m (also available in smaller quantities for a surcharge)

Accessories

1 sales unit = 10 pieces (also available as self-service packaging on request)



Inside corner 90°
SB = 5 x 4 pieces

Outside corner 90°
SB = 5 x 2 pieces

End caps
left and right
SB = 5 x 1 pair each

Connectors with
cable exit
SB = 5 x 4 pieces

Colour selection
beech dark
maple
beech natur
oak light
aluminium
white
light grey

oak antique
old ash
clooney
ligna
racine
rachel
tibidabo

ulm
acacia dark
acacia light
walnut brown
limed oak
oak concise
oak white (not for SB)



Inside corner 135°

Outside corner 135°

SB = 1 AE + 1 IE (5 packs)

**Colour selection
(135° Ecken)**
white
aluminium

Base profile GP 20

- 1 sales unit = 20 x 2,50 m

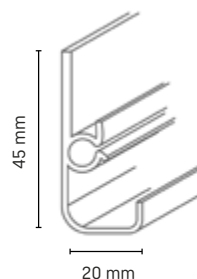

Colours (Decor profile)



System SL 48



Suitable for the following types of flooring

- System skirting board specifically designed for laminate floors, hard floors, and elastic floors

Product information

- Consists of decor profile DP 48 and base profile GP 20 made of chlorine-free Polyblend based on PS or PP, with a large cable channel
- Clean floor and wall finish thanks to flexible soft lips at the top and bottom

Processing recommendations



Döllken Hot-Melt Glue



UZIN Tape



Döllken Skirting scissors



Döllken Notching Pliers

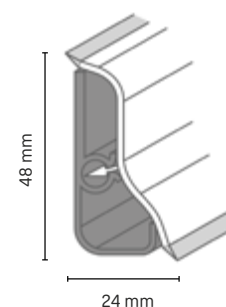

- The base profile must be ordered separately.

All sales channels

- 1 sales unit = 20 x 2,50 m (also available in smaller quantities for a surcharge)

Accessories

1 sales unit = 10 pieces (also available as self-service packaging on request)



Inside corner 90°
SB = 5 x 4 pieces

Outside corner 90°
SB = 5 x 2 pieces

End caps left and right
SB = 5 x 1 pair each

Connectors with cable exit
SB = 5 x 4 pieces

Colour selection
maple
beech light
beech dark
aluminium
oak
oak grey
white
walnut
clooney
ligna
racine
rachel

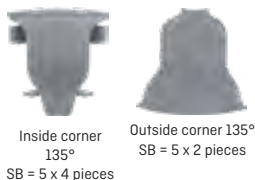

Inside corner 135°
SB = 5 x 4 pieces

Outside corner 135°
SB = 5 x 2 pieces

Colour selection (135° Ecken)
white
aluminium

Base profile GP 20
1 sales unit = 20 x 2,50 m

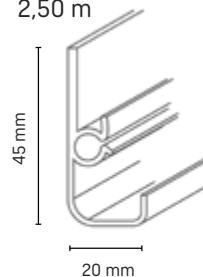

Colours (Decor profil)

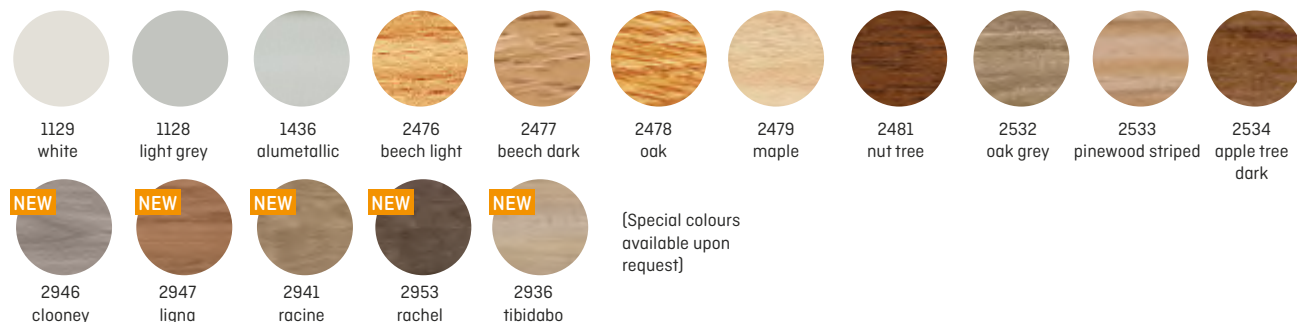

NEW

NEW

NEW

NEW

NEW

(Special colours available upon request)

SLK 50 | Plastic Skirting Board Classic 50



Suitable for the following types of flooring

- Skirting board suitable for all types of flooring, especially laminate floors

Product information

- Large selection of modern decors
- Easy installation by screwing or gluing
- Cable duct for invisible laying of media cables
- Flexible soft lip for a clean floor and wall finish
- Matching decor accessories available

Processing recommendations



Döllken Hot-Melt Glue



Döllken Skirting scissors

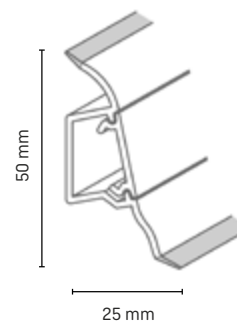

All sales channels

- 1 sales unit = 20 x 2,50 m
- 1 sales unit = 10 x 2,50 m

Accessories



Inside corner 90°
SB = 5 x 2 pieces

Outside corner 90°
SB = 5 x 1 pieces

End caps
left and right
SB = 5 x 2 pieces

Connectors
SB = 5 x 2 pieces

Colours (1 sales unit = 20 x 2,50 m)



2150
oak
sardinia



2151
oak
corsica



2140
oak



2126
mountain
apple



1436
alu metallic



2092
acacia dark



2087
beech yellow



2141
progress



2125
walnut
virginia

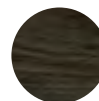

2145
valentino



2149
wenge

Colours (1 sales unit = 10 x 2,50 m)



1137
white



2080
oak vogesen



2099
oak
rustic



2100
acacia
queensland



2119
nut valencia



2135
tamari



2137
essencial



2085
beech dark



2143
flavour



2087
beech yellow

SLK 60 „Q“ | Cable Channel Skirting Cubica 60 sk



Suitable for the following types of flooring

- System skirting board suitable for all types of floor coverings, especially for laminate floors

Product information

- Wide selection of modern decors
- **Self-adhesive** - easy installation
- Cable channel for invisible installation of media cables
- Flexible soft lips for a clean floor and wall finish
- Accessories in matching decor
- Also available without self-adhesive tape upon request – installation by screws or adhesive

Processing recommendations



Döllken Hot-Melt Glue



Döllken Skirting scissors

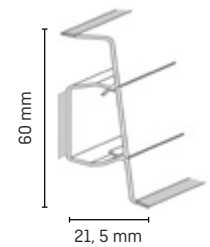

All sales channels

- 1 sales unit = 10 x 2,50 m

Accessories



Inside corner 90°
SB = 5 x 2 pieces

Outside corner 90°
SB = 5 x 1 pieces

End caps left and right
SB = 5 x 2 pieces

Connectors
SB = 5 x 2 pieces

Colours



1137 white

3040 wasabi oak

3047 natural oak

3048 oak silver

3160 beech

3166 pine

3168 driftwood oakgrey

3161 sea pine

3167 hemlock rustik

3170 royal elm

Plastic skirting boards



On every type of flooring, a true highlight

The plastic skirting boards made by Döllken Profiles are unique and offer various features and advantages:

- Impressive appearance on various types of flooring
- Available in numerous heights and shapes
- Moisture-resistant
- Provide an optimal finish for various types of textile, elastic, and hard floor coverings
- All ingredients of the skirting boards comply with REACH standards
- Numerous decors and high-quality appearance

Overview of the plastic skirting boards

(Wholesale | All sales channels)

	Page
HSL 6	54
HSL 8 & HSL 10	56
USL 60 Hard foam skirting board Modern 60	57
USL 60 Cubica Hard foam skirting board Cubica 60	58
USL 60 Cubica sk.	59
USL 60 Clip Foam skirting board Modern 60 Clip	60
Foam skirting board Modern 60 Clip sk	61
USL 50 Foam profile Classic 50	62
TL 51 Carpet Strip 50	63
RL 10	64
TLE 55	65
TLE 55 sk.	65
TL 55 Carpet skirting board 55	66
KL 60	67
Tile renovation skirting board	68
Hard foam finishing profile	70
Design skirting board DSL 60	71

HSL 6



Suitable for the following types of flooring

- Universal skirting boards for all types of flooring

Product information

- Polyblend based on PVC (all ingredients are REACH compliant)
- More flexibility due to a more robust surface and improved soft lips that adapt to floor and wall irregularities and allow for a seamless finish
- Moisture-resistant

Processing recommendations



Döllken Mitre Tool



Döllken Hot-Melt Glue



Döllken Notching Pliers



Döllken Skirting scissors



UZIN Tape

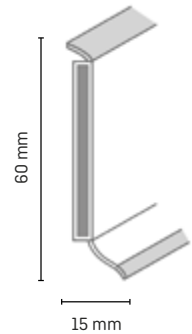

Wholesale

- 1 sales unit = 25 x 4 m

Colours

2620 maple	2202 silver grey	2171 oak	2273 beech	2216 ramin	2217 oak rustic	1088 light beige	2221 fir antique	2224 bomanga	2223 paduck	2222 ikarus
2220 sea oak	2225 mahogany	1111 dark blue	2219 chestnut	0110 black	1051 grey	2218 chocolate wenge	1074 silver	1109 greenblue	1135 white	1245 champagne
2365 oak light	2336 lakeside beech	2587 traditional oak	2572 fashion oak	2033 calypso	2660 chene gris	2428 alder	2032 twist	2386 malua	2574 country oak	2580 grey cherry
				[Special colours available upon request]						
2357 plank country stained	2395 moon island	1408 white	1049 dark grey							

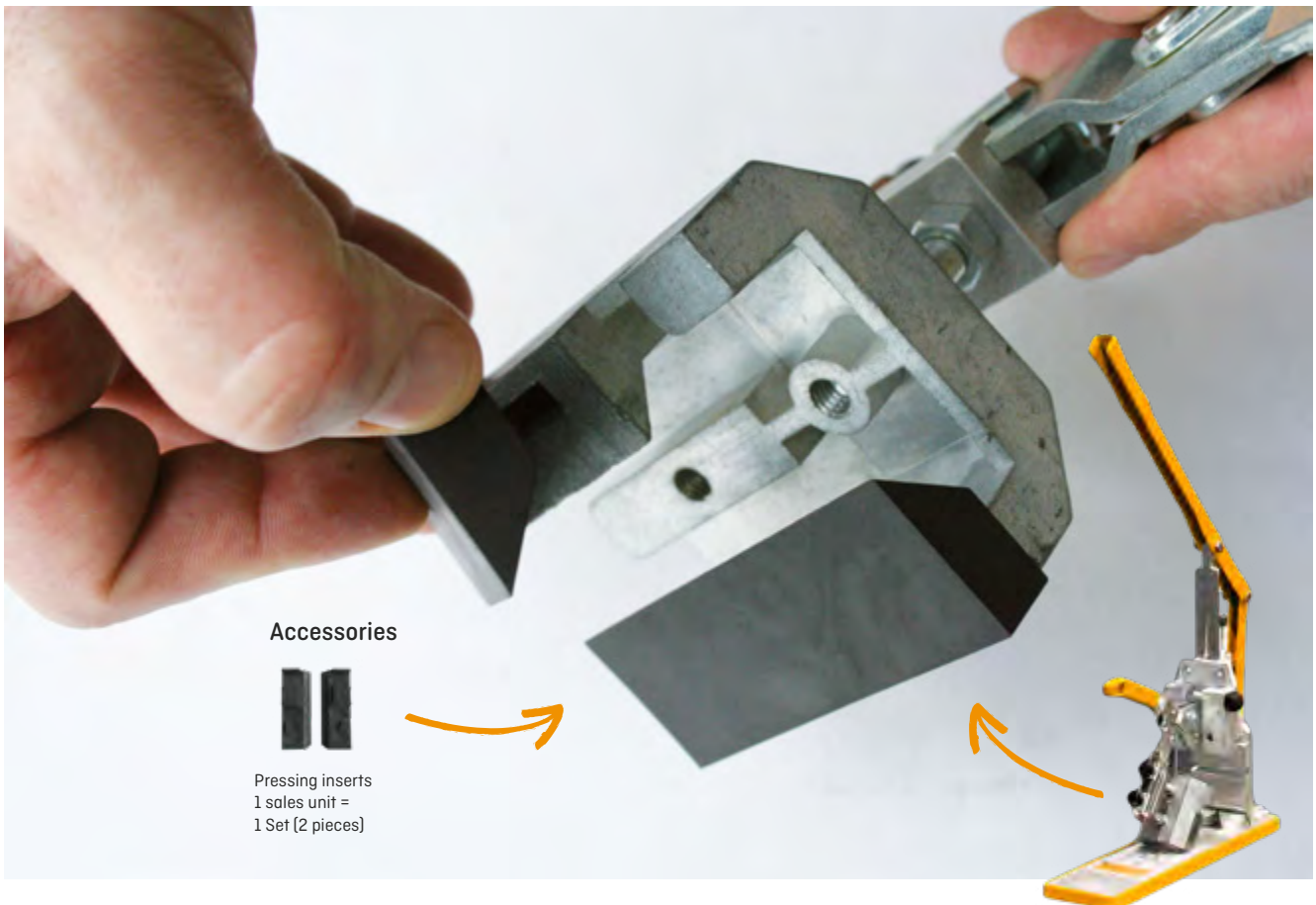

Accessories



Pressing inserts
1 sales unit =
1 Set (2 pieces)

All sales channels

• 1 sales unit = 20 x 2,5 m

Colours

1088 light beige	2202 silver grey	2171 oak	2219 chestnut	2220 sea oak	2221 fir antique	2224 bomanga	1048 dark brown	1049 dark grey	0110 black	1051 grey
1074 silver	1135 white	1111 dark blue	1110 blue	2273 beech	2218 chocolate wenge	1245 champagne	1408 white	2365 oak light	2336 lakeside beech	2587 traditional oak
2572 fashion oak	2033 calypso	2660 chene gris	2428 alder	2032 twist	2386 malua	2574 country oak	2580 grey cherry	2357 plank country stained	2395 moon island	

HSL 8 & HSL 10



Suitable for the following types of flooring

- Universal skirting boards for all types of flooring

Product information

- Polyblend based on PVC (all ingredients are REACH-compliant)
- More flexibility due to a more robust surface and improved soft lips that adapt to uneven floors and walls, allowing for a seamless finish
- Moisture-resistant

Processing recommendations



Döllken
Mitre Tool



Döllken Hot-
Melt Glue



Döllken
Skirting scissors



Döllken
Notching Pliers

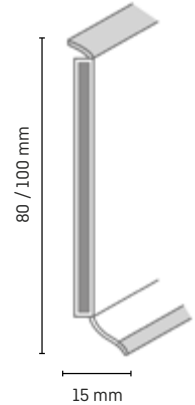

All sales channels

- 1 sales unit = 20 x 2,5 m

Accessories



Pressing inserts
1 sales unit = 1 Set
(2 pieces)

Colours HSL 8



2620
maple



2202
silver grey



2171
oak



2273
beech



2220
sea oak



2245
nut tree antique



1088
light beige



1048
dark brown



1049
dark grey



1135
white



0110
black



1051
grey

Colours HSL 10



1088
light beige



1049
dark grey



1135
white



0110
black



1051
grey

USL 60 | Hard foam skirting board Modern 60



Suitable for the following types of flooring

- Particularly suitable for laminate floors

Product information

- Polyblend based on PVC (REACH-compliant)
- Moisture-resistant
- Quick and easy installation by nailing or gluing (no clips required)

Processing recommendations



Wholesale

- 1 sales unit = 10 x 4 m

Accessories

1 sales unit = 10 pieces

Colour selection*

- uni white
- uni beech
- uni grey
- uni silver
- uni oak
- uni rustic
- uni antique
- uni black

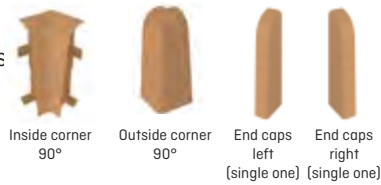

Colours



All sales channels

- 1 sales unit = 10 x 2,50 m

Accessories

1 sales unit = 5 piece:

Colour selection*

- uni white
- uni beech
- uni grey
- uni silver
- uni oak
- uni rustikal
- uni antique
- uni black

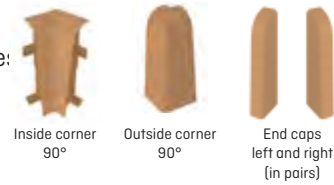

Colours (Special colours available upon request)

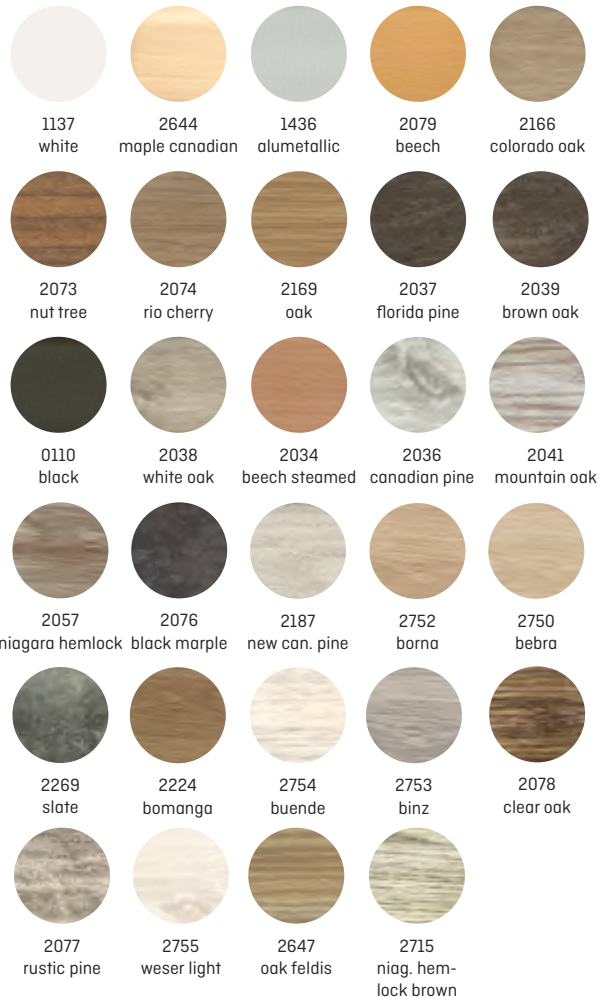

* The colours of the accessory parts do not match the decor of the skirting board. For a consistent appearance, cut the skirting board at a mitre joint.

i
You can find suitable molding decor assignments on our website at www.doellken-profiles.com
(Products > Plastic skirting boards > USL 60 > Accessories)

USL 60 Cubica | Hard foam skirting board Cubica 60



Suitable for the following types of flooring

- Design floors, vinyl, LVT
- Laminate
- PVC, linoleum

Product information

- Polyblend based on PVC
(all ingredients are REACH-compliant)
- Moisture-resistant
- Numerous decor foils available.

Processing recommendations



ClipStar
Metal Type G



Döllken
Skirting scissors



Mitre Saw

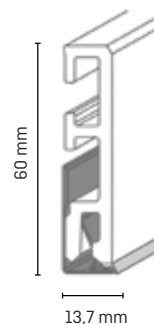

All sales channels

- 1 sales unit = 10 x 2,5 m

Accessories

- End caps
SB: 5 x 2 pieces



End caps
left and right
(in pairs)

Colour selection (SB)

white	pale brown	oak
silk grey	grey	
ivory	ochre brown	

- ClipStar Metal Type G

1 sales unit = 10 packs include 50 pieces
oder 1 sales unit = 10 packs include 20 pieces

Colours USL 60 Cubica



i

The USL 60 Cubica can be combined with the decor surfaces of the USL 60 Cubica SK (p.59), Cubu Touch & Style, Cubu Stone & Style and Cubu Premium. You can find them on pages 28 to 31. Minimum order quantity: available from 1000 m!

USL 60 Cubica sk



Suitable for the following types of flooring

- Design flooring, Vinyl, LVT
- Laminate
- PVC, Linoleum

Product information

- Polyblend based on PVC
(all ingredients are REACH compliant)
- Moisture-resistant
- Available in numerous decorative films
- **Self-adhesive version** (two adhesive strips applied to the profile backside at the factory)

Processing recommendations



Mitre saw

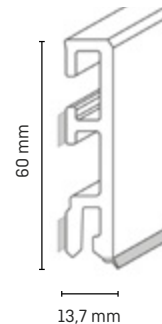

All sales channels

- 1 sales unit = 10 x 2,5 m

Colours USL 60 Cubica self-adhesive version

3163 ancona	2348 oak modern	3184 oak padua	3143 oak fa tren	3172 oak vers	3158 stone bari
3144 pine country	3147 white oak	3164 milano	3148 canadian pine	3149 niagara hemlock	3150 florida pine
3151 colorado oak	2832 slate light	3346 natural oak	3348 oak white	3347 oak grey	3289 midland oak white
3290 brio oak	3209 oak dark grey	3291 oak sand	3292 midland oak	3293 midland oak brown	3231 skagen oak
3294 oak moorland	3295 country oak	3221 oak grey	1005 white	1132 white	3219 oak

[Special colours available upon request]

Accessories

SB: 5 x 2 pieces



End caps left and right (in pairs)

Colour selection (SB)

- white
- silk grey
- ivory
- pale brown
- grey
- ochre brown
- oak light
- silver
- oak

Matching colours Accessories

Decor skirting board	End caps
ancona	3163 silk grey
oak siena	2348 oak
oak padua	3184 oak
oak fa.tren	3143 oak
oak vers.	3172 oak light
stone bari	3158 grey
pine country	3144 oak
white oak	3147 silk grey
milano	3164 silver
canadian pine	3148 ivory
niagara hemlock	3149 oak
florida pine	3150 oak
colorado oak	3151 oak
slate light	2832 silver
natural oak	3346 oak
oak white	3348 silk grey
oak grey	3347 silk grey
midland oak white	3289 ivory
brío oak	3290 silver
oak dark grey	3209 silver
oak sand	3291 silk grey
midland oak	3292 silver
midland oak brown	3293 oak
skagen oak	3231 oak
oak moorland	3294 oak
country oak	3295 grey
oak grey	3221 silk grey
white	1005 white
white	1132 white
oak	3219 oak

USL 60 Clip | Foam skirting board Modern 60 Clip



Also available as a self-adhesive version on request!

Suitable for the following types of flooring

- Particularly suitable for laminate floors

Product information

- Polyblend based on PVC (all ingredients are REACH compliant)
- Moisture-resistant
- Newly integrated soft lip guarantees a clean finish
- Available in numerous decors with a high-quality appearance
- Also available as a **self-adhesive version** (2 mm thick foam adhesive tape applied to the profile backside at the factory)

Processing recommendations



ClipStar Metall Typ G



Döllken Hot-Melt Glue



Döllken Skirting scissors



Mitre saw

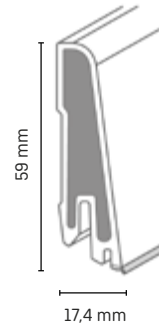

All sales channels

- 1 sales unit = 10 x 2,5 m

Accessories

- **Moulding parts**

Bulk pack:
1 sales unit = 10 pieces
SB: 5 pieces

- ClipStar Metal Type G

1 sales unit = 10 packs include 50 pieces
oder 1 sales unit = 10 packs include 20 pieces



Inside corner 90°



Outside corner 90°



End caps left and right (in pairs)

Suitable decor-matching moldings can be found on our website at www.doellken-profiles.com under [Products > Plastic skirting boards > USL 60 Clip > Accessories].

Colour selection (bulk pack)

oak light
oak
uni silver
white
champagne

Colour selection (SB)

slate grey
beige
brown
ochre brown
silk grey
pale brown
ivory
uni silver
white
oak
oak light
grey

Colours

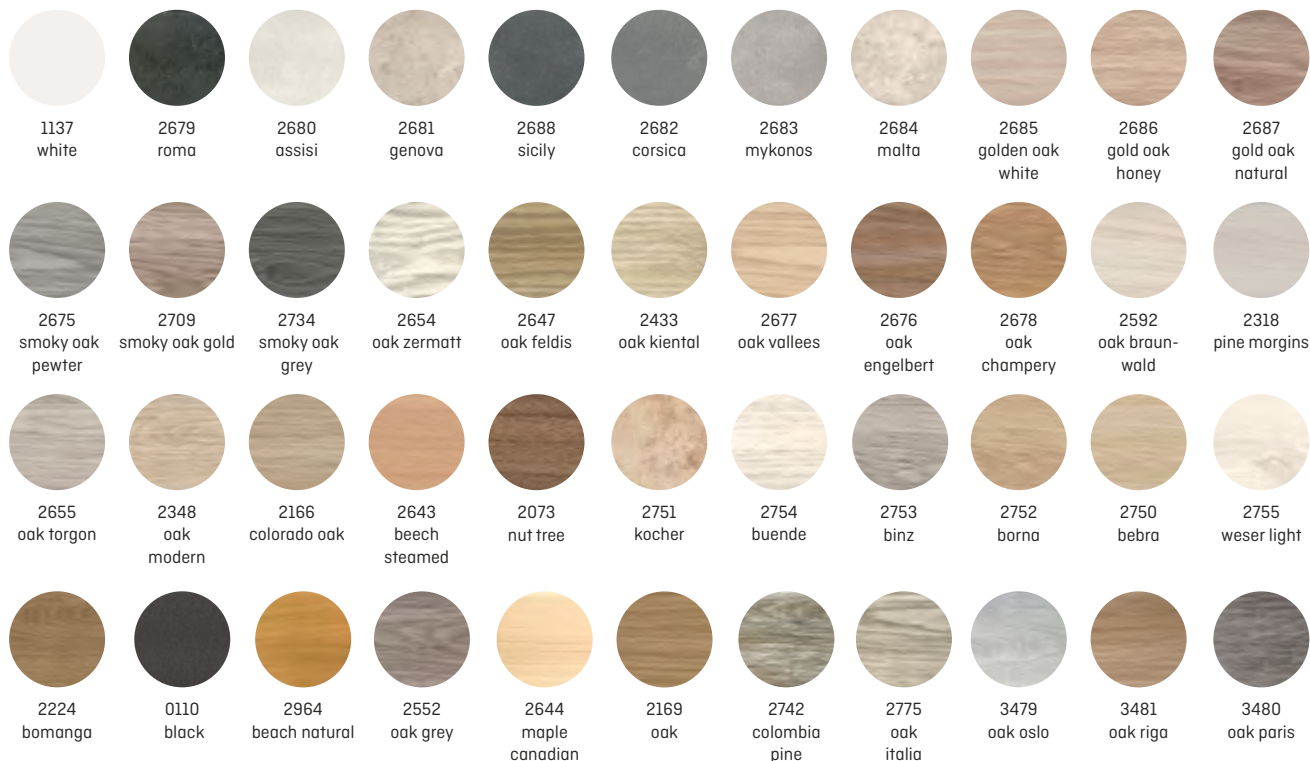

(Special colours available upon request)

Foam skirting board Modern 60 Clip SK



Suitable for the following types of flooring

- Particularly suitable for laminate floors

Product information

- Polyblend based on PVC (all ingredients are REACH compliant)
- Moisture-resistant
- Newly integrated soft lip guarantees a clean finish
- Available in numerous decors with a high-quality appearance
- **Self-adhesive version** available (2 mm thick foam adhesive tape applied to the profile backside at the factory)

Processing recommendations



Döllken
Skirting scissors



Mitre
saw

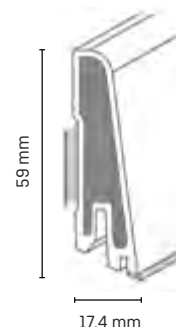

All sales channels

- 1 sales unit = 10 x 2,5 m

Accessories

• Moulding parts

Bulk pack:
1 sales unit =
10 pieces
SB: 5 pieces



Inside corners
90°



Outside corner
90°



End caps
left and right
(in pairs)

Colour selection (Bulk pack)

uni oak light
uni oak
uni silver
uni white
uni champagne

Colour selection (SB)

slate grey	silk grey	white
beige	pale brown	oak
brown	ivory	oak light
ochre brown	uni silver	grey

- ClipStar Metal Type G

1 sales unit = 10 packs include 50 pieces
oder 1 sales unit = 10 packs include 20 pieces

Colours



2398
natural oak



3161
seapine



3169
pine grizzly



3167
hemlock Ru



3163
ancona



2348
oak modern



3184
oak padua



3164
milano



2832
slate light

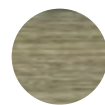

3165
oak grey



3172
oak vers.



3185
refined Oak



1131
grey



2166
colorado
oak



3162
oak oel



1137
white



2396
oak orient

[Special colours
available upon
request]

USL 50 | Foam profile Classic 50



Suitable for the following types of flooring

- Universal skirting board suitable for all types of flooring, especially for laminate floors

Product information

- Made of Polyblend based on PVC
- All ingredients are compliant with REACH regulations
- Resistant to moisture

Processing recommendations

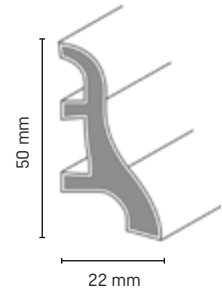
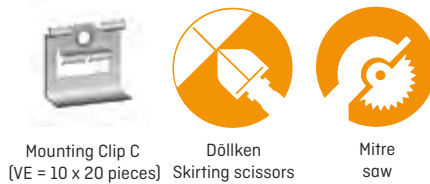

Wholesale

- 1 sales unit = 25 x 4 m oder 40 x 2,50 m

Accessories

Bulk pack: 1 sales unit = 10 pieces

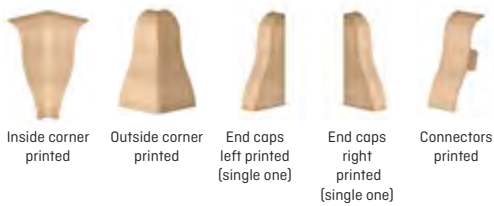

All sales channels

- 1 sales unit = 20 x 2,50 m

Colours

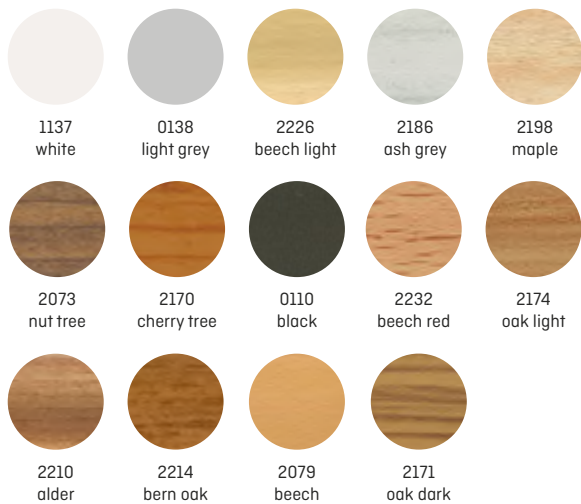

[Special colours available upon request]

Colours



[Special colours available upon request]

TL 51 | Carpet Strip 50



Suitable for the following types of flooring

- Carpet adhesive strip with a flange for attaching carpet strips

Product information

- Made of Polyblend based on PVC
- All ingredients are compliant with REACH regulations
- Colour-matching accessories (unified)
- Comes with self-adhesive front for carpeting

Wholesale

- 1 sales unit = 25 x 4 m

Accessories

1 sales unit = 10 pieces



Inside corner
90°



Outside corner
90°



End cap
left
(single)



End cap
right
(single)

Colours



0117
white

(Special colours available upon request)

Processing recommendations



Döllken
Skirting scissors

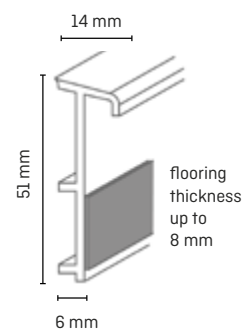

All sales channels

- 1 sales unit = 20 x 2,5 m

Accessories

1 sales unit = 5 pieces



Inside corner
90°



Outside corner
90°



End caps
left and right
(paarweise)

Colours



0117
white



2172
beech



2175
oak



2186
silver grey



0146
dark grey

RL 10



Suitable for the following types of flooring

- Renovation skirting board for the renovation of existing skirting boards

Product information

- Made of Polyblend based on PVC
- All ingredients are compliant with REACH regulations
- For the renovation of existing skirting boards, with self-adhesive front for attaching carpet strips

Processing recommendations



Döllken Hot-Melt Glue

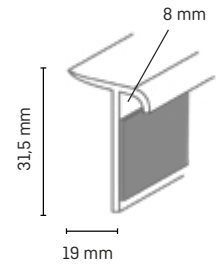

All sales channels

- 1 sales unit = 20 x 2,5 m

Colours



1137
white

TLE 55



Suitable for the following types of flooring

- Carpet skirting board for attaching carpet strips with an elastic top

Product information

- Made of Polyblend based on PVC
- All ingredients are compliant with REACH regulations
- With an elastic top

Processing recommendations



Döllken Hot-Melt Glue



UZIN Tape



Döllken Skirting scissors



Assembly Hammer

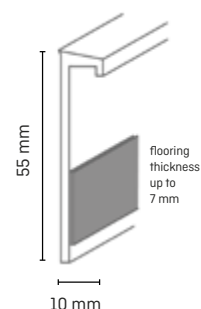

Wholesale

- 1 sales unit = 25 x 4 m

Colours



0117 white



0581 white grey



0138 light grey



2175 oak light



0130 beige



2073 nut tree



1388 blue



0146 dark grey



0132 brown



0110 black

TLE 55 sk



self-adhesive

Suitable for the following types of flooring

- Carpet skirting for self-adhesive installation of carpet strips

Product information

- Made of Polyblend based on PVC (all ingredients comply with REACH).
- Equipped with self-adhesive back for quick installation on the wall side.
- With an elastic top

Processing recommendations



Döllken Skirting scissors



Assembly Hammer

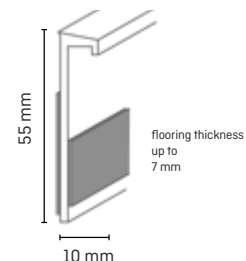

Wholesale

- 1 sales unit = 25 x 4 m

Colours



0117 white

TL 55 | Carpet skirting board 55

Also available as self-adhesive version

Suitable for the following types of flooring

- Carpet skirting for attaching carpet strips with hard top

Product information

- Made of Polyblend PVC (all ingredients are REACH-compliant)
- With a hard top

Processing recommendations



Döllken Hot-Melt Glue



UZIN Tape



Döllken Skirting scissors

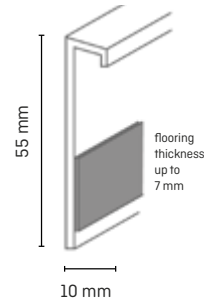

Wholesale

- 1 sales unit = 25 x 4 m

Colours

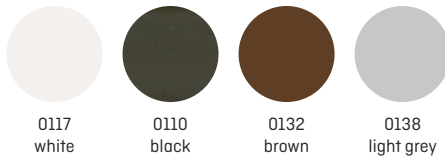

0117
white

0110
black

0132
brown

0138
light grey

All sales channels

- 1 sales unit = 20 x 2,50 m

Colours

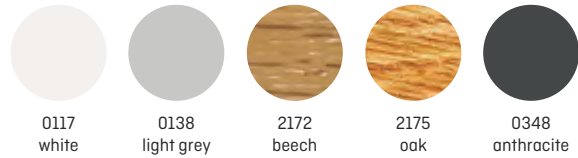

0117
white

0138
light grey

2172
beech

2175
oak

0348
anthracite

Colours (self-adhesive version)

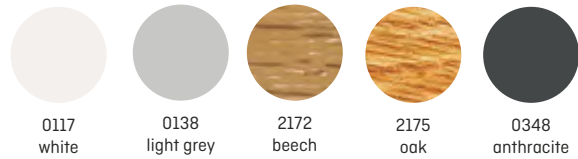

0117
white

0138
light grey

2172
beech

2175
oak

0348
anthracite



2073
nut tree

KL 60



Suitable for the following types of flooring

- Suitable for all types of floor coverings

Product information

- Made of plastic, with cable channel
- For invisible installation with carrier strip

On request, also available as perforated version* (from 300 running meters order quantity/colour)!

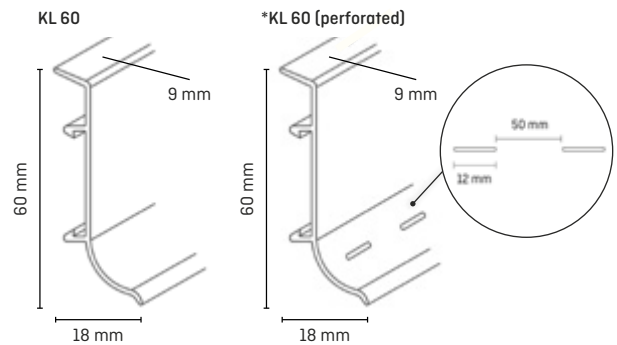

All sales channels

- 1 sales unit = 20 x 5,0 m

Colours KL 60



1137
white

0130
beige

1083
light grey

0146
dark grey

Base profile KT 45/27

- Base profile must be ordered separately

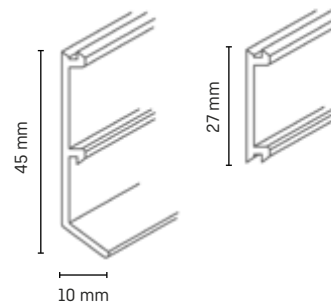

We recommend using fitschen pins with clamping dowels for installation. You can find them on page 152.



Tile renovation skirting board



Suitable for the following types of flooring

- For renovation work with PVC, linoleum, and LVT

Product information

- Made of Polyblend based on PVC (all ingredients are REACH-compliant)
- Designed to cover old tile bases and skirting boards (with a maximum cover of up to 17 mm)
- Can be trimmed to different heights

Processing recommendations



Döllken
Fugenfill



Mitre Saw

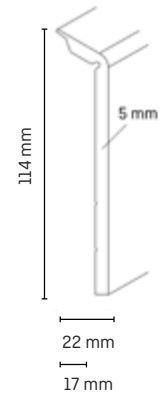

All sales channels

- 1 sales unit = 20 x 2,50 m

Colours



1135
white



1064
silver grey



1087
brown



Hard foam finishing profile



Suitable for the following types of flooring

- Suitable for carpets, vinyl, and wood floors

Product information

- Can be used as a front panel in combination with other skirting boards or used independently
- Easy and flexible to process - can be flexibly adapted to the wall by heating
- Universally applicable, even in wet rooms
- Very robust and resistant
- UV-stable
- Paintable

Processing recommendations



Döllken
Skirting Board Pins



Mitre Saw



Döllken
Skirting scissors

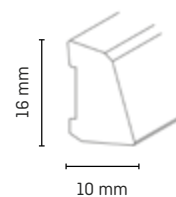

All sales channels

- 1 sales unit = 20 x 2,50 m

Colours

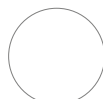

1137
white,

Design skirting board DSL 60

Also available as self-adhesive version!



Suitable for the following types of flooring

- Design skirting board for the attachment of design flooring strips

Product information

- Made of Polyblend based on PVC (all ingredients are REACH-compliant)
- Quick and easy installation with self-adhesive strips on the front side (for the self-adhesive variant, both sides)
- Suitable for all types of flooring with a thickness of up to 5 mm

Processing recommendations



Döllken Hot-Melt Glue



UZIN Tape



Döllken Skirting scissors

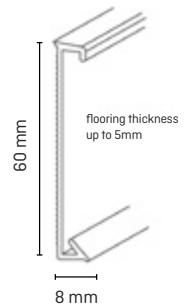

All sales channels

• 1 sales unit = 10 x 2,50 m

Colours



1137 white



1091 chocolate brown



1083 stainless steel



1084 sand



1063 silver



1064 silver grey

Colours (self-adhesive version)



cappuccino



chocolate



light beige



sand



Wall and Special Profiles

Reliable protection for heavily used areas

The special profiles are characterized by the following properties and advantages:

- Elegant transition between different surfaces
- Secure fixation of various floor coverings on stairs
- Flexible and absolutely reliable in use
- Compliant with REACH regulations, free from harmful plasticizers

Overview Wall and Special Profiles

(Wholesale | All sales channels)

	Page
TAL 20	75
TEL 20 life	76
TEL 20 life rund	76
TIW 20 life	77
TEL 40 life	77
Door frame profile	78
Door frame profile XL	78
WL 10/10, 20/20, 30/30	79
Corner profile 20	79
HK 15x15 / HK 20x20/ HK 25x25 / HK 30x30	80
EL 3,5 / EL 3,5 sk / EL 8	80
HK 100	80
HK 100	81
HK 15/15, 20/20, 25/25	81
EL 3,5	82
EL 8	83
Heating Pipe Cover Profile	84
Universal flat strip self-adhesive	85
Quarter round 12	86
Quarter round 15	87

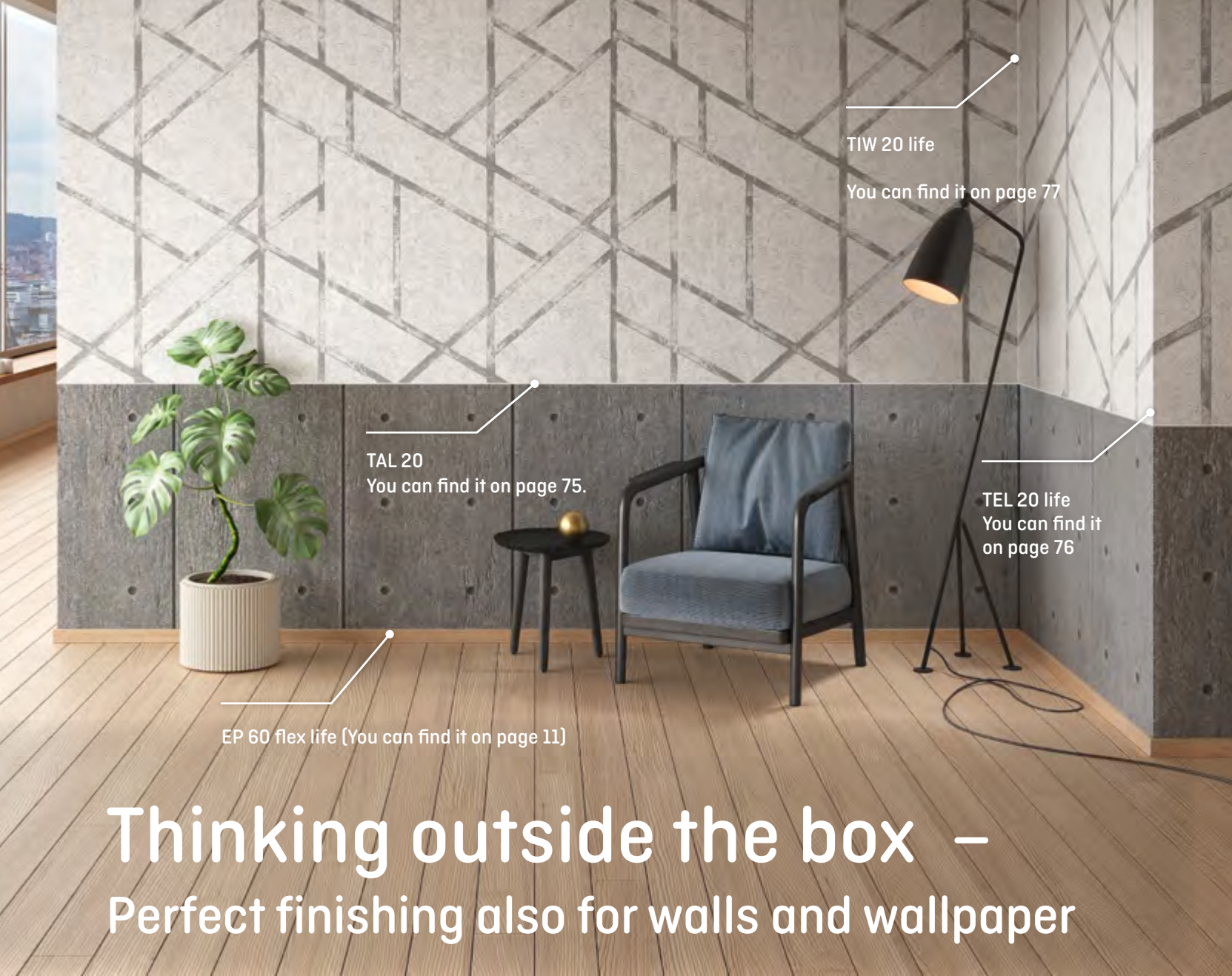

TIW 20 life

You can find it on page 77

TAL 20

You can find it on page 75.

TEL 20 life

You can find it on page 76

EP 60 flex life [You can find it on page 11]

Thinking outside the box – Perfect finishing also for walls and wallpaper



TIW 20 life



TAL 20



TEL 40 life

TAL 20



- Wall profile for clean wallpaper finishes

Product information

- Made of Polyblend based on ABS, for easy and clean elaboration of wallpaper transitions
- Paintable
- Finish for various transitions (e.g. borders, wallpapers, etc.), window and door reveals.

Processing recommendations



Döllken
Skirting scissors



Döllken
Mitre Shears

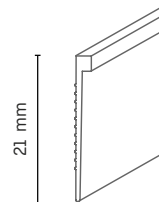

All sales channels

- 1 sales unit = 40 x 2,60 m

Colours



1137
white

TCF
totally
chlorine-
free

TEL 20 life

- Corner profile for clean wallpaper finishes (external corner)

Product information

- Made of Polyblend based on ABS for easy and clean corner finishing
- Paintable
- Can be separated and used as a finish
- For blunt angles, simply notch

Processing recommendations



Döllken
Skirting scissors



Döllken
Mitre Shears

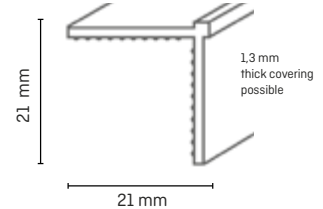

All sales channels

- 1 sales unit = 20 x 2,60 m

Colours



1137
white



1015
bronze



1016
black metallic



1017
silver metallic



1018
gold metallic

TCF
totally
chlorine-
free

TEL 20 life round

- Rounded corner profile for clean wallpaper finishes (external corner), particularly suitable for sensitive areas such as kindergartens

Product information

- Made of Polyblend based on ABS for easy and clean corner finishing
- Paintable
- Can be separated and used as a finish
- For blunt angles, simply notch

Processing recommendations



Döllken
Skirting scissors



Döllken
Mitre Shears

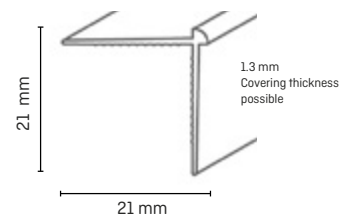

All sales channels

- 1 sales unit = 20 x 2,60 m

Colours



1137
white

TCF
totally
chlorine-
free

TIW 20 life

- Internal angle for clean wallpaper finishes

Product information

- Made of Polyblend based on ABS for easy and clean corner finishing
- Paintable
- For blunt angles, simply notch

Processing recommendations



Döllken Skirting scissors



Döllken Mitre Shears

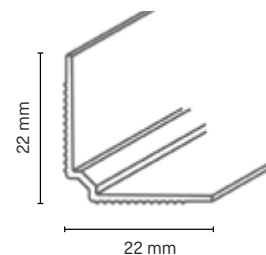

All sales channels

- 1 sales unit = 20 x 2,60 m

Colours



1137 white

TCF
totally
chlorine-
free

TEL 40 life

- Corner profile for clean wallpaper finishes (external corner)

Product information

- Made of Polyblend based on ABS for easy and clean corner finishing
- Paintable
- Can be separated and used as a finish
- Suitable for thicker wall coverings

Processing recommendations



Döllken Skirting scissors



Döllken Mitre Shears

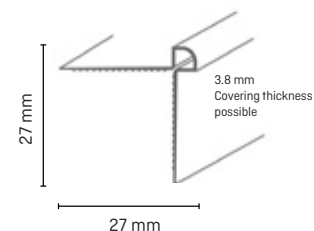

All sales channels

- 1 sales unit = 20 x 2,60 m

Colours



1137 white

TCF
totally
chlorine-
free

Door frame profile



Suitable for the following use

- For framing door openings and for a harmonious continuation/connection with skirting boards

Product information

- HDF core, wrapped with chlorine-free PP/TPE Polyblend and with a flexible soft lip on top
- Can be seamlessly continued along the door
- Specially curved geometry ensures better mounting on the door frame edge

Processing recommendations



Döllken
Hot-Melt Glue

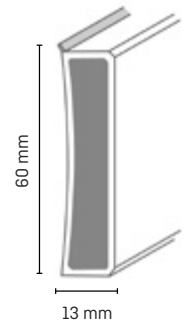

All sales channels

- 1 sales unit = 10 x 2,20 m

Colours



1013
white



1171
white



0110
black

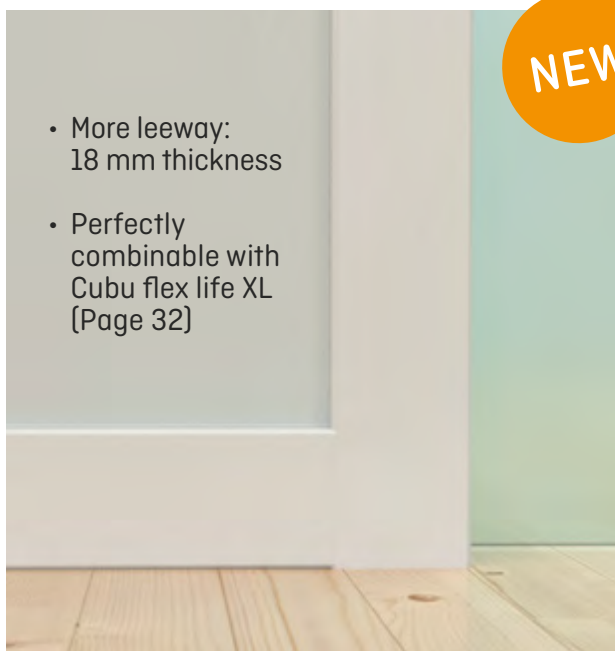

- More leeway:
18 mm thickness
- Perfectly combinable with
Cubu flex life XL
(Page 32)



Door frame profile XL

- 1 sales unit = 8 x 2,20 m

Processing recommendations



Döllken
Hot-Melt Glue

Colours



1013
white



0110
black

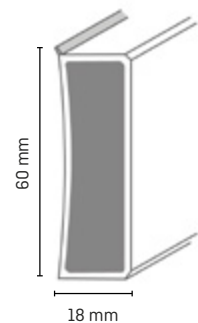

WL 10/10, 20/20, 30/30



Suitable for the following types of coverings

- All-rounder for covering internal and external corners of all kinds

Product information

- Made of Polyblend based on PVC (all ingredients are REACH-compliant)
- Printed on both sides

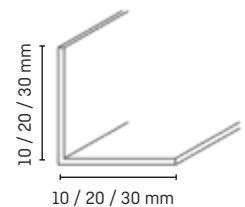

All sales channels

- WL 10/10: 1 sales unit = 20 x 2,5 m*
- WL 20/20: 1 sales unit = 10 x 2,5 m
- WL 30/30: 1 sales unit = 10 x 2,5 m

Colours



1137
white



2186
ash grey



2198
maple



2172
beech



2175
oak



2227
oak rustic



0110
black

*WL 10/10 only available in white!

Corner profile 20



Suitable for the following types of coverings

- All-rounder for covering indoor corners of all kinds

Product information

- Made of rigid plastic foam



All sales channels

- 1 sales unit = 20 x 2,5 m

Colours



1137
white



2198
maple



2186
ash grey



2079
beech



2171
oak

Fillet skirting boards

One-piece system:
HK 100

Two-piece system:
HK 15x15 / HK 20x20/
HK 25x25 / HK 30x30
+ EL 3,5 / EL 3,5 sk / EL 8

To meet the increased hygiene requirements in sensitive environments with elastic floor coverings, the fillet skirting boards are used in cleanrooms and sterile environments, such as commercial kitchens, food industry, laboratories or hospitals. By forming a hollow curve, the floor coverings can be cleaned more easily in the skirting area, reducing the accumulation of dirt.

- ✓ Enables perfect formation of fillet skirting
- ✓ The curve simplifies cleaning and maintenance
- ✓ Prevents accumulation of dirt and bacteria
- ✓ Protects against flooring breakage in the curve area

For more information about our products, please refer to the following pages.

HK 100



Suitable for the following types of flooring

- Fillet skirting boards for elastic floor coverings

Product information

- Polyblend based on PVC (all ingredients are REACH-compliant)
- For floor coverings with high edges on the wall side

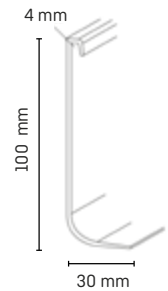

All sales channels

- 1 sales unit = 40 x 2,50 m

Colours

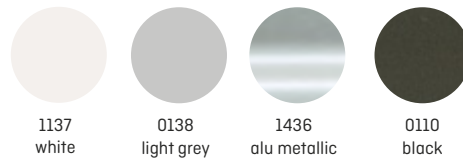

HK 15/15, 20/20, 25/25



Suitable for the following types of flooring

- Fillet skirting boards for elastic floor coverings

Product information

- Polyblend based on PVC (all ingredients are REACH-compliant)
- For floor coverings with high edges on the wall side

Processing recommendations



Döllken
Skirting scissors



UZIN
Tape



All sales channels

- HK 15/15: 1 sales unit = 20 x 2,5 m
- HK 20/20: 1 sales unit = 20 x 2,5 m
- HK 25/25: 1 sales unit = 20 x 2,5 m

Colours



uni

EL 3,5



Suitable for the following types of flooring

- Fillet skirting boards for elastic floor coverings

Product information

- Polyblend based on PVC (all ingredients are REACH-compliant)
- Suitable for floor coverings with high edges on the wall side

Processing recommendations



Döllken
Skirting scissors



Döllken
Mitre Shears

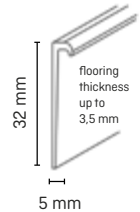

Wholesale

- 1 sales unit = 25 x 4 m

Colours



1137
white



0138
light grey



0146
dark grey



0130
beige



0132
brown



0110
black

Self-adhesive version: EL 3,5 sk

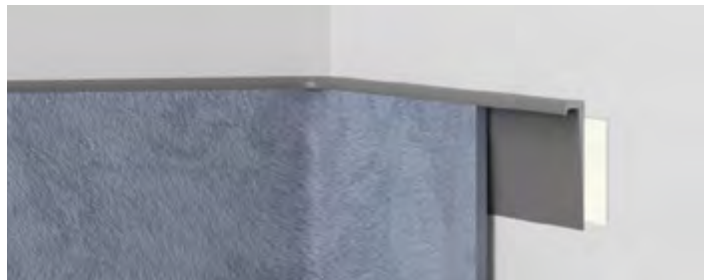

Suitable for the following types of flooring

- Fillet skirting boards for elastic floor coverings

Product information

- Polyblend based on PVC (all ingredients are REACH-compliant)
- Suitable for floor coverings with high edges on the wall side
- Equipped with self-adhesive:
 - strong adhesion **with Toptac brand adhesive tape from UZIN**
 - ✓ System guarantee
 - ✓ Dimensionally stable
 - ✓ Solvent-free
 - ✓ Resistant to plasticizers

Processing recommendations



Döllken
Skirting scissors



Döllken
Mitre Shears

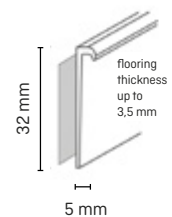

Wholesale

- 1 sales unit = 20 x 2,50 m

Colours



1137
white



0138
light grey



0146
dark grey



0130
beige



0132
brown



0110
black

EL 8



Suitable for the following types of flooring

- Edging strip

Product information

- Polyblend based on PVC (all ingredients are REACH-compliant)

Processing recommendations



Döllken
Skirting scissors



Döllken
Mitre Shears

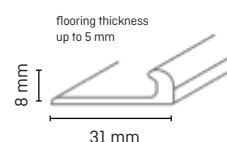

Wholesale

- 1 sales unit = 25 x 4 m

Colours



1137
white



0138
light grey



0146
dark grey



0130
beige



0132
brown



0110
black

Heating Pipe Cover Profile

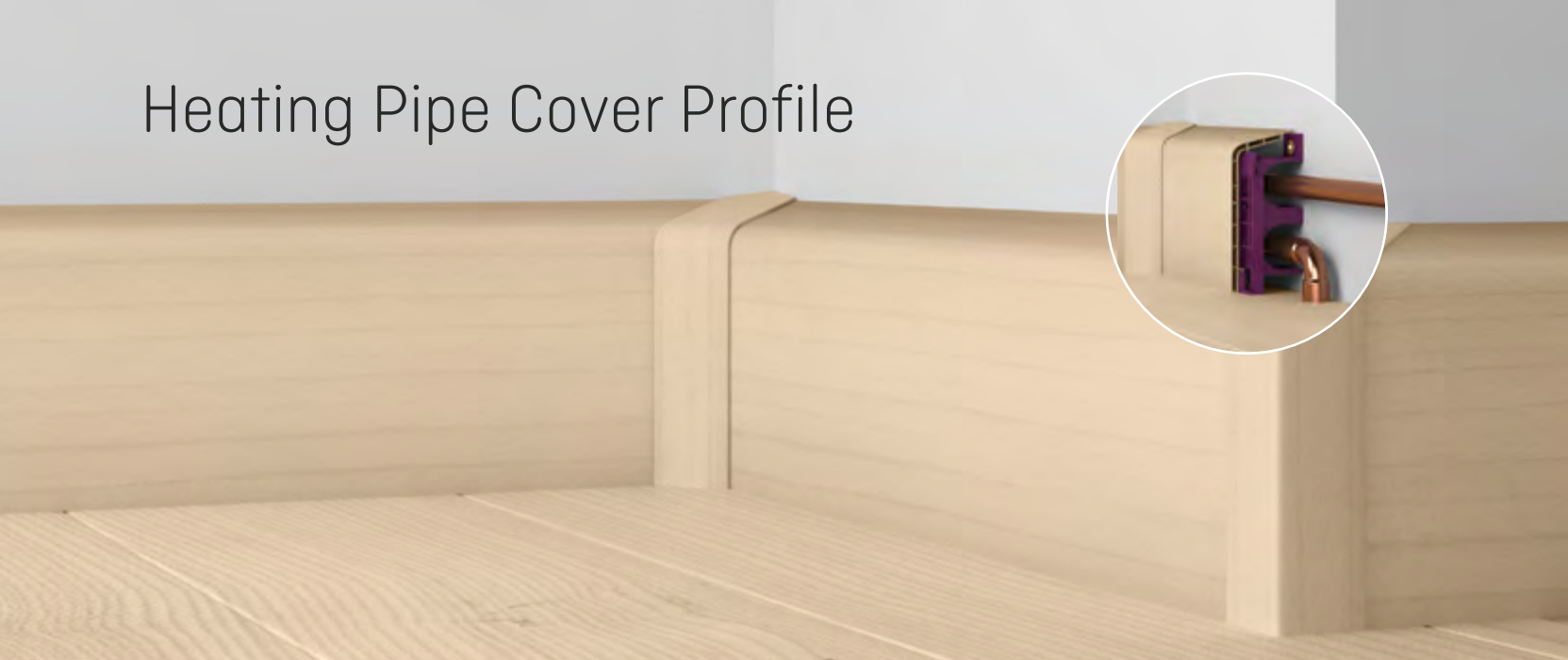

Suitable for the following types of flooring

- Universally applicable

Product information

- Hard plastic film-coated
- Made of "double-walled" plastic
- Soft plastic lip facilitates installation even on uneven walls
- Pipe clamps serve to stabilize heating pipes and as a means of securing the strip
- Decor-matching accessories for perfect installation
- Roughly cut at a miter joint (accessories cover the cut)

Processing recommendations



Mitre Saw



Döllken Notching Pliers

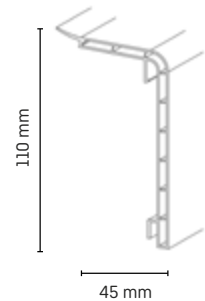

All sales channels

- 1 sales unit = 10 x 2 m

Accessories

SB: 1 sales unit = 5 x 1 piece

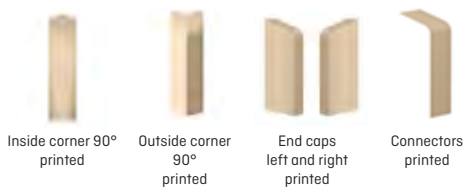

Inside corner 90° printed

Outside corner 90° printed

End caps left and right printed

Connectors printed

Befestigung

- Mounting pipe clamp
- SB: 1 sales unit = 10 x 5 pieces

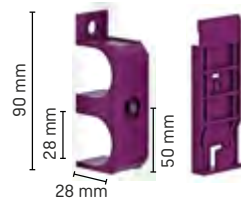

Easily and quickly with the notching pliers
Notches for the heating pipes can be punched out.



Colours



1013 white



3800 beech light



3783 oak



1012 light grey

Universal flat strip self-adhesive

NEW!

Suitable for the following types of flooring

- Cover strip for e.g. balcony or patio doors

Product information

- HDF core, coated with chlorine-free polyblend based on PP
- Surface is resistant to mechanical stress and moisture
- Quick and easy installation thanks to the rear self-adhesive tape
- Can be punched (closed outside corner)

Processing recommendations



Döllken
Mitre Tool



Döllken
Skirting scissors



Döllken
Mitre Shears

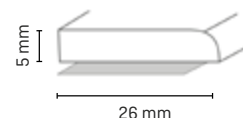

All sales channels

- 1 sales unit = 40 x 2,50 m

Colours

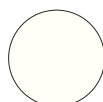

1013
white



1209
anthracite



1408
white



1063
silver



1010
cappucino



Quarter round 12



Suitable for the following types of flooring

- PVC molding for laminate

Product information

- Made of plastic foam (PVC)
- Miter cuts can be made with a fine-toothed saw
- Can be mounted by screws, nails, or adhesive
- Flexibly adaptable to slight wall curvatures
- Versatile applications due to common decors and colours

Processing recommendations



Döllken
Skirting Board Pins



Döllken
Skirting scissors



Döllken
Mitre Shears

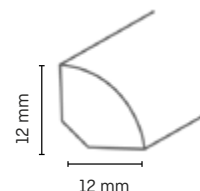

All sales channels

- 1 sales unit = 20 x 2,0 m

Colours



1137
white



2186
ash grey



2198
maple



2079
beech



2171
oak

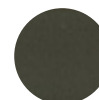

0110
black

Quarter round 15



Suitable for the following types of flooring

- PVC trim for laminate flooring

Product information

- Made of plastic foam (PVC)
- Miter cuts possible with a fine-tooth saw
- Mounting options include screws, nails, or adhesive
- Flexible adaptation to slight wall curvatures
- Available in a variety of popular designs and colours for versatile use

Processing recommendations



Döllken
Skirting Board Pins



Döllken
Skirting scissors



Döllken
Mitre Shears

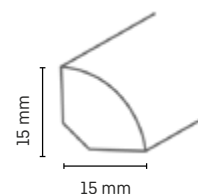

All sales channels

- 1 sales unit = 20 x 2,5 m

Colours



1137
white



2171
oak



2244
ash



2079
beech



0110
black



1055
dark grey

Flexible Soft Skirting Boards



For particularly sensitive environments, we also have a solution for you. Upon request, the flexible soft skirting boards are also available in an antibacterial variant! Do you have any questions? Feel free to contact our service hotline at: +49 3643 4170 711.



Free from harmful plasticizers: In accordance with the REACH regulation, the flexible soft skirting boards are phthalate-free.

The quick way to achieve a perfect finish – flexible & uncomplicated

The soft skirting boards are characterized by the following properties and benefits:

- suitable for use on flexible floor coverings
- easily installed in no time
- create a harmonious connection between the wall and the floor
- all soft skirting boards are phthalate-free, in accordance with the REACH regulations
- all soft skirting boards can also be equipped with antibacterial properties upon request

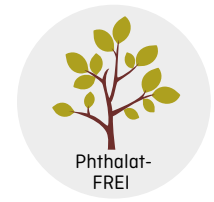

Overview Flexible Soft Skirting Boards

(Wholesale | All sales channels)

	Page
WL 50, 60, 80, 100	90
WLK 50, 60	94
WLK 70, 80, 100	95
WLK 50, 60, 80, 100 life	96
WLK 20 Remur	97
Flexible soft skirting board basic	98
Angle basic	99

Just as flexible as our skirting boards is our service. Upon request, other heights are also available in the PVC-free life version and with a self-adhesive option.



WL 50, 60, 80, 100



Suitable for the following types of flooring

- Soft skirting board for PVC, CV and linoleum floor coverings

Product information

- Made of Polyblend based on PVC (all ingredients are REACH-compliant)



Processing recommendations



UZIN
Tape



Assembly
Hammer



Mitre
Shears



Easy-Scooter



Skirting scissors



All sales channels

- 1 sales unit = 1 x 50 m (rolled)

Colours WL 50

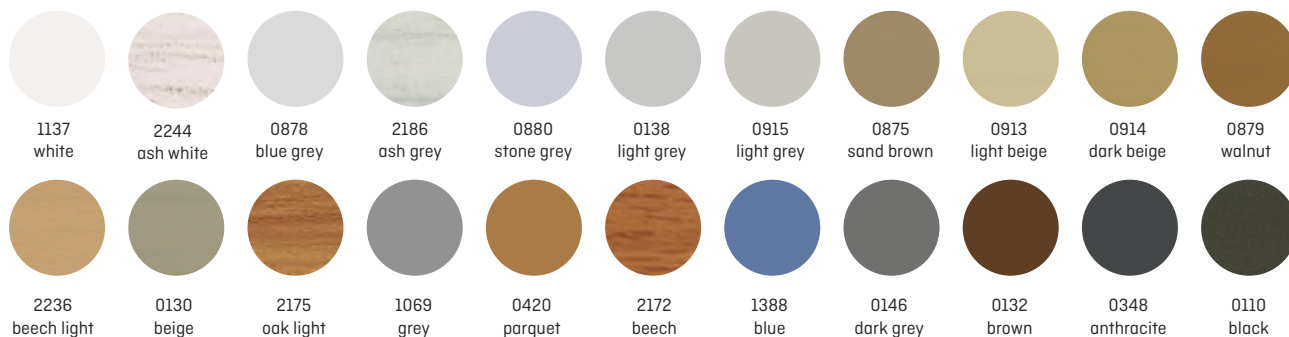

Colours WL 60



Colours WL 80, WL 100

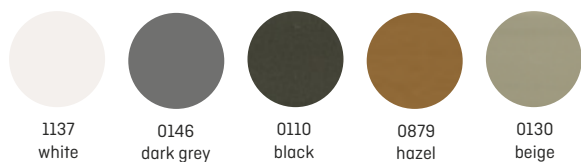

Because we keep the most important thing in focus, all of our soft skirting boards are phthalate-free.



For particularly sensitive environments, we also have a solution for you. Upon request, the soft skirting boards are also available as an antibacterial version! Do you have any questions about it? Please feel free to contact our service hotline at: +49 3643 4170 711.



Stronger than ever,
it sticks like never before!



The self-adhesive WLK flexible skirting series:

- ✓ New geometry for more flexibility.
- ✓ Strong adhesion thanks to branded adhesive tape.
- ✓ Up to 50% time saving due to pre-applied adhesive.
- ✓ Easy-Scooter also facilitates installation.



Scan now and watch processing tips
on our YouTube channel!

WLK 50, 60



Suitable for the following types of flooring

- Flexible skirting board for PVC, CV, and linoleum floor coverings

Product information

- Made of Polyblend based on PVC (all ingredients comply with REACH regulations)
- Equipped with self-adhesive backing: strong adhesion with **Remur brand adhesive tape from UZIN**
 - ✓ System guarantee
 - ✓ Dimensionally stable
 - ✓ Solvent-free
 - ✓ Resistant to plasticizers



Processing recommendations



Assembly Hammer



Easy-Scooter



Skirting scissors

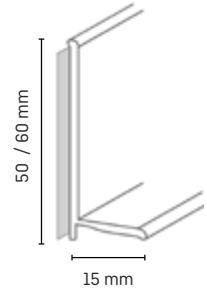

All sales channels

- 1 sales unit = 1 x 50 m (rolled)

Colours WLK 50



Colours WLK 60



WLK 70, 80, 100



Suitable for the following types of flooring

- Flexible skirting board for PVC, CV, and linoleum floor coverings

Product information

- Made of Polyblend based on PVC (all ingredients comply with REACH regulations)
- Equipped with self-adhesive backing: strong adhesion with **Remur brand adhesive tape from UZIN**
 - ✓ System guarantee
 - ✓ Dimensionally stable
 - ✓ Solvent-free
 - ✓ Resistant to plasticizers



Processing recommendations



Assembly Hammer



Easy-Scooter



Skirting scissors

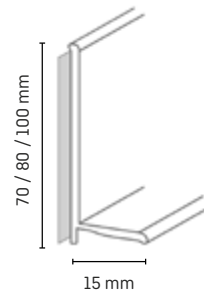

All sales channels

- 1 sales unit = 1 x 50 m (rolled)

Colours WLK 70

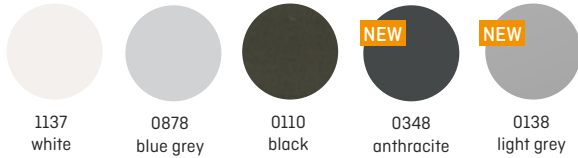

Colours WLK 80

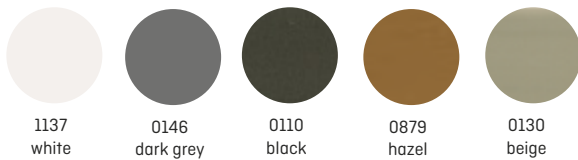

Colours WLK 100

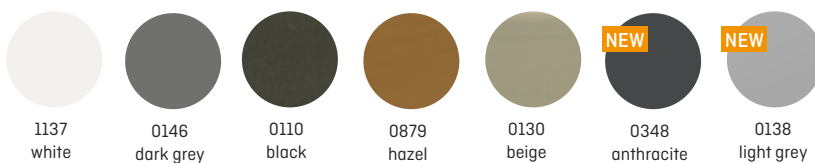

WLK 50, 60, 80, 100 life

Discontinued

Suitable for the following types of flooring

- Flexible skirting board for PVC, CV, and linoleum floor coverings

Product information

- Made of elastic, chlorine-free Polyblend based on EVA-PE mixture
- Chlorine and plasticizer-free
- Equipped with self-adhesive backing with brand adhesive tape



www.blauer-engel.de/uz120

Processing recommendations



Assembly
Hammer



Easy-
Scooter



Skirting
scissors

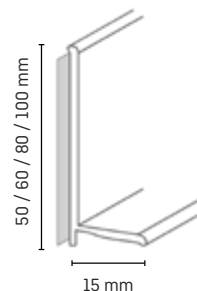

All sales channels

- 1 sales unit = 1 x 50 m (rolled)

Colours WLK 50 life, 60 life, 80 life, 100 life



1137
white



0110
black

Other decors available
upon request!

WLK 20 Remur



Suitable for the following types of flooring

- Flexible skirting board for PVC, CV, and linoleum floor coverings

Product information

- Made of Polyblend based on PVC (all ingredients comply with REACH regulations)
- Can be used as an inside and outside corner
- Bendable
- Equipped with self-adhesive backing:
strong adhesion with **Remur brand adhesive tape from UZIN**
 - ✓ System guarantee
 - ✓ Dimensionally stable
 - ✓ Solvent-free
 - ✓ Resistant to plasticizers

Processing recommendations



Assembly Hammer



Easy-Scooter



Skirting scissors

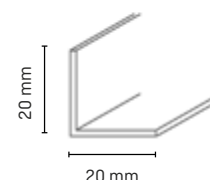

All sales channels

- 1 sales unit = 1 x 50 m (rolled)

Colours



1137
white



0146
dark grey

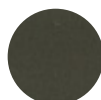

0110
black

Flexible soft skirting board basic



Suitable for the following types of flooring

- Flexible skirting board for PVC, CV, and linoleum floor coverings

Product information

- Made of Polyblend based on PVC (all ingredients comply with REACH regulations)
- Equipped with factory-applied self-adhesive backing

Processing recommendations



Assembly
Hammer



Döllken
Skirting
scissors

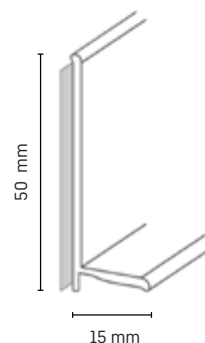

For a dimensionally stable bonding, we recommend using the WLK profiles with Remur (see page 94, 95, and 97).

All sales channels

- 1 sales unit = 4 x 25 m
- 1 sales unit = 5 x 10 m



Colours (1 sales unit = 4 x 25 m)



white

grey

beech

oak

Colours (1 sales unit = 5x 10 m)



white

grey

black

grey beige

beech

ash grey

oak

oak
rustikal

brown

Angle basic



Suitable for the following types of flooring

- Flexible skirting board for PVC, CV, and linoleum floor coverings

Product information

- Soft plastic skirting
- Equipped with a self-adhesive fixing aid
- Can be used as internal and external corner
- Flexible and bendable
- Equipped with a factory-applied adhesive tape

Processing recommendations



Assembly Hammer



Döllken Skirting scissors

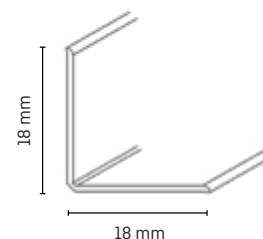

For a dimensionally stable bonding, we recommend using the WLK profiles with Remur (see page 94, 95, and 97).

All sales channels

- 1 sales unit = 4 x 25 m**
- 1 sales unit = 5 x 5 m



Colours



white**

grey

black

brown

grey beige

beech

light grey

oak

oak rustic

nut tree



Flooring profiles

Reliable protection for heavily used areas

The floor profiles are characterized by the following features and benefits:

- elegant connection of transitions
- secure fixation of a wide range of coverings on stairs
- absolutely reliable
- compliant with REACH regulations, free of harmful plasticizers

Overview Flooring Profiles

(Wholesale | All sales channels)

	Page
TKNG A 40	104
TKNG A 40 sk	105
TKNG A 45	106
TKNG A 45 sk	107
TKNG A 65	108
TKNG A 65 sk	109
TKNG 3,5 40	110
TKNG 2,5 40	111
Stair stringer profile TWP45/3	112
Stair mat angle	112
Edge strip SK	113
Doppel edge strip SK	114
Plastic transition profile	115
Transition profile SK	115

The new and innovative TKNNG stair nosing program

We have taken stair edges to the next level with our new TKNNG series. Whether you choose a surface-mounted or flush-mounted profile, the luminous edge of these stair nosings will make them a bright highlight. The installation is quick and easy, saving time and nerves.



Slip-resistant
at least slip resistance class R 10



Quick installation
...even faster with the self-adhesive versions



Luminous edge protects and guides in low-light

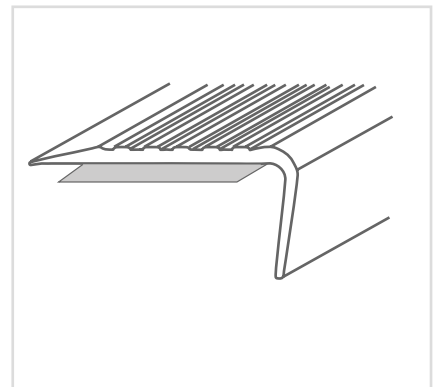
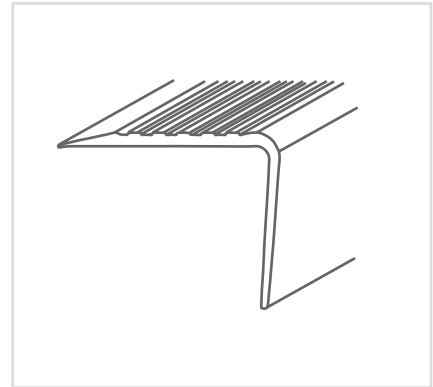

Phthalate-free:
Safe to use in sensitive
areas or living spaces.

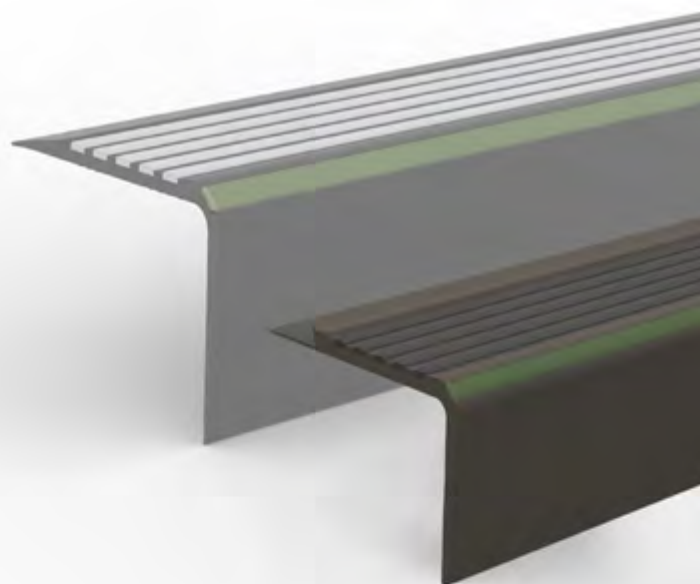

Colour combination	TKN-GA40	TKNG A45	TKNG A65	TKNG 2,5 40	TKNG 3,5 40
light grey/dark grey	✓	✓	✓	✓	✓
dark grey/light grey	✓	✓	✓	✓	✓
black/light grey	✓	✓	✓	✓	✓
aluminium/dark grey	✓	✓	✓	✓	✓
NEW: black/black	✓	✓	✓	✓	✓
champagne/dark grey	✓	✓	✓	✓	✓
NEW: dark grey/dark grey	✓	✓	✓	✓	✓
self-adhesive version available	✓	✓	✓	-	-

Special colours and individual colour combinations available on request!

NOW NEW: TKNG A 40, A 45 and A 65 also available in self-adhesive versions!



- ✓ easy, fast & clean: 3 - 5 times faster installation
- ✓ solvent-free bonding
- ✓ strong adhesion with Remur branded adhesive tape from UZIN
- ✓ replaceable at any time
- ✓ no need for spreading adhesive or laying out beforehand

TKNG A 40

glow-in-the-dark edge

Suitable for the following types of flooring

- Step edge or overlay profile for design flooring, CV and linoleum

Product information

- Made of polyblend based on PVC (all ingredients are REACH-compliant)
- Slim appearance
- Slip-resistant due to textured surface (according to DIN 51130:2014 - Slip resistance class **R10**)
- Protects against falls in the dark with phosphorescent/glow-in-the-dark edge

Processing recommendations



Döllken
Skirting
scissors



Assembly
Hammer



Döllken
Mitre Shears

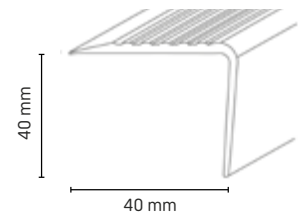

All sales channels

- 1 sales unit = 10 x 2,5 m (also available in smaller quantities for a surcharge)



The luminous edge protects against tripping and falling in the dark!



Colours



Basic colour
Profile
Colour of
grooves

0138
light grey
0146
dark grey

0146
dark grey
0138
light grey

1160
aluminium
0146
dark grey

0110
black
0138
light grey

1245
champagne
0146
dark grey

NEW
0110
black
0110
black

NEW
0146
dark grey
0146
dark grey

TKNG A 40 sk



glow-in-the-dark edge

Suitable for the following types of flooring

- Step edge or overlay profile for design flooring, CV and linoleum

Product information

- Made of polyblend based on PVC (all ingredients are REACH-compliant)
- Slim appearance
- Slip-resistant due to textured surface (according to DIN 51130:2014 - Slip resistance class **R10**)
- Protects against falls in low light conditions with phosphorescent/glow-in-the-dark edge
- **Self-adhesive version** with Remur branded adhesive tape from UZIN

Processing recommendations



Döllken Skirting scissors



Assembly Hammer



Döllken Mitre Shears

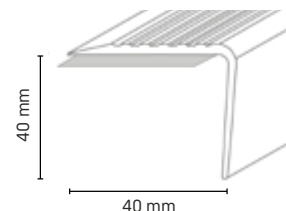

All sales channels

- 1 sales unit = 10 x 2,5 m (also available in smaller quantities for a surcharge)



The luminous edge protects against tripping and falling in the dark!



Colours

Basic colour Profile	0138	0146	1160	0110	1245	0110	0146
Colour of grooves	0146	0138	0146	0138	0146	0110	0146
	light grey	dark grey	aluminium	black	champagne	black	dark grey
	dark grey	light grey	dark grey	light grey	dark grey	black	dark grey



- 3-5 times faster installation ✓
- Solvent-free bonding, strong adhesion ✓
- No need for underlayment & pre-coating of adhesive ✓



Watch the easy installation now!

TKNG A 45

glow-in-the-dark edge

Suitable for the following types of flooring

- Stair edging or overlay profile for design flooring, CV and linoleum

Product information

- Overlay profile made of Polyblend based on PVC (all ingredients comply with REACH regulations)
- Slim appearance
- Slip-resistant due to textured walking surface (according to DIN 51130:2014 - slip resistance class at least **R10**)
- Provides protection against falls in the dark with phosphorescent/ glowing edge.

Processing recommendations



Döllken Skirting scissors



Assembly Hammer



Döllken Mitre Shears

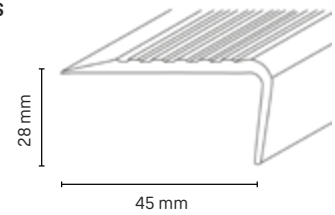

All sales channels

- 1 sales unit = 10 x 2,5 m (also available in smaller quantities for a surcharge)



The luminous edge protects against tripping and falling in the dark!



Colours

	0138	0146	1160	0110	1245	0110	0146
Basic colour	light grey	dark grey	aluminium	black	champagne	black	dark grey
Profile	light grey	dark grey	aluminium	black	champagne	black	dark grey
Colour of grooves	0146	0138	0146	0138	0146	0110	0146
	dark grey	light grey	dark grey	light grey	dark grey	black	dark grey

TKNG A 45 sk



Suitable for the following types of flooring

- Stair edge or overlay profile for design floors, CV and linoleu

Product information

- Overlay profile made of Polyblend based on PVC (all ingredients are REACH compliant)
- Slim appearance
- Slip-resistant due to textured tread surface (according to DIN 51130:2014 - slip resistance class at least **R10**)
- Protects against falls in the dark with phosphorescent / luminous edge
- **Self-adhesive version** with Remur-brand adhesive tape from UZIN

Processing recommendations



Döllken Skirting scissors



Assembly Hammer



Döllken Mitre Shears

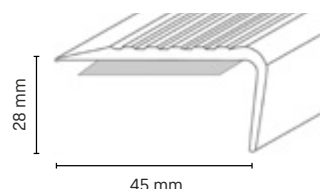

All sales channels

- 1 sales unit = 10 x 2,5 m (also available in smaller quantities for a surcharge)



The luminous edge protects against tripping and falling in the dark!



Colours of the self-adhesive version

Basic colour	0138	0146	1160	0110	1245	0110	0146
Profile	light grey	dark grey	aluminium	black	champagne	black	dark grey
Colour of grooves	0146	0138	0146	0138	0146	0110	0146
	dark grey	light grey	dark grey	light grey	dark grey	black	dark grey



- 3-5 times faster installation ✓
- Solvent-free bonding, strong adhesion ✓
- No need for underlayment & pre-coating of adhesive ✓



Watch the easy installation now!



TKNG A 65



Suitable for the following types of flooring

- Stair edges or nosing profiles for design coverings, CV and linoleum

Product information

- Nosing profile made of polyblend based on PVC (all ingredients comply with REACH)
- Slim appearance
- Slip-resistant due to structured surface (according to DIN 51130:2014 - slip resistance class at least R10)
- Protects against falls in the dark with phosphorescent/glow-in-the-dark edge.

Processing recommendations



Döllken Skirting scissors



Assembly Hammer



Döllken Mitre Shears

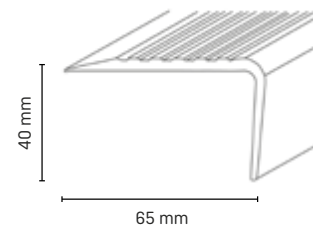

All sales channels

- 1 sales unit = 10 x 2,5 m (also available in smaller quantities for a surcharge)



The luminous edge protects against tripping and falling in the dark!



Colours



Basic colour	0138	0146	1160	0110	1245	0110 NEW	0146 NEW
Profile	light grey	dark grey	aluminium	black	champagne	black	dark grey
Colour of grooves	0146	0138	0146	0138	0146	0110	0146
	dark grey	light grey	dark grey	light grey	dark grey	black	dark grey

TKNG A 65 sk

self-adhesive version

glow-in-the-dark edge

Suitable for the following types of flooring

- Stair edges or nosing profiles for design coverings, CV and linoleum

Product information

- Nosing profile made of polyblend based on PVC (all ingredients comply with REACH)
- Slim appearance
- Slip-resistant due to structured surface (according to DIN 51130:2014 - slip resistance class at least R10)
- Protects against falls in the dark with phosphorescent/glow-in-the-dark edge
- **Self-adhesive version** available upon request with Remur branded adhesive tape by UZIN

Processing recommendations



Döllken Skirting scissors



Assembly Hammer



Döllken Mitre Shears

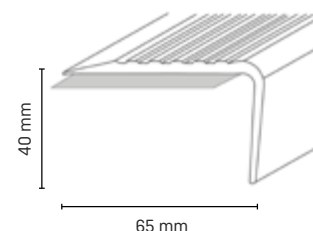

All sales channels

- 1 sales unit = 10 x 2,5 m (also available in smaller quantities for a surcharge)



The luminous edge protects against tripping and falling in the dark!



Colours of the self-adhesive version

Basic colour	0138	0146	1160	0110	1245	0110	0146
Profile	light grey	dark grey	aluminium	black	champagne	black	dark grey
Colour of grooves	0146	0138	0146	0138	0146	0110	0146
	dark grey	light grey	dark grey	light grey	dark grey	black	dark grey



3-5 times faster installation ✓

Solvent-free bonding, strong adhesion ✓

No need for underlayment & pre-coating of adhesive ✓



Watch the easy installation now!



TKNG 3,5 40

glow-in-the-dark edge

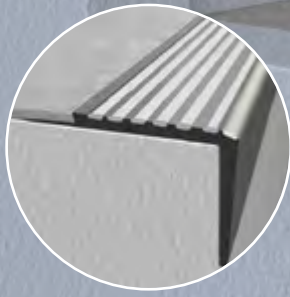

Suitable for the following types of flooring

- Stair edges or nosing profiles for design coverings, CV and linoleum

Product information

- Nosing profile made of polyblend based on PVC (all ingredients comply with REACH)
- Slim appearance
- Slip-resistant due to structured surface (according to DIN 51130:2014 - slip resistance class at least **R10**)
- Phosphorescent/glow-in-the-dark edge

Processing recommendations



Döllken Skirting scissors



Assembly Hammer



Döllken Mitre Shears

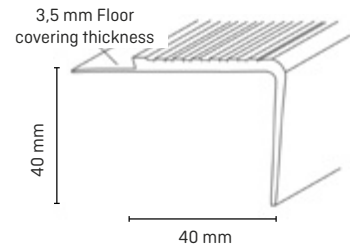

All sales channels

- 1 sales unit = 10 x 2,5 m (also available in smaller quantities for a surcharge)

Colours



Basic colour 0138
Profile light grey
Colour of grooves dark grey



0146 dark grey
0138 light grey



1160 aluminium
0146 dark grey



0110 black
0138 light grey

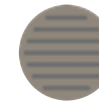

1245 champagne
0146 dark grey



NEW
0110 black
0110 black



NEW
0146 dark grey
0146 dark grey



The luminous edge protects against tripping and falling in the dark!

i

The glow-in-the-dark stair edges TKNG...

TKNG 2,5 40

glow-in-the-dark edge

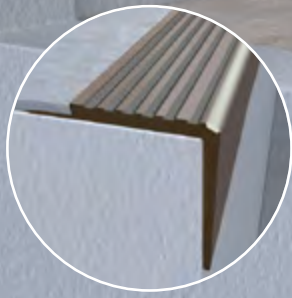

Suitable for the following types of flooring

- Stair edges or nosing profiles for design coverings, CV and linoleum

Product information

- Nosing profile made of polyblend based on PVC
- (all ingredients comply with REACH)
- Slim appearance
- Slip-resistant due to structured surface (according to DIN 51130:2014 - slip resistance class at least **R10**)
- Phosphorescent/glow-in-the-dark edge

Processing recommendations



Döllken Skirting scissors



Assembly Hammer



Döllken Mitre Shears

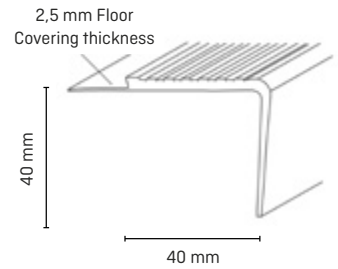

All sales channels

- 1 sales unit = 10 x 2,5 m (also available in smaller quantities for a surcharge)



Colours

Basic colour	0138	0146	1160	0110	1245	0110	0146
Profile	light grey	dark grey	aluminium	black	champagne	black	dark grey
Colour of grooves	0146	0138	0146	0138	0146	0110	0146
	dark grey	light grey	dark grey	light grey	dark grey	black	dark grey

The luminous edge protects against tripping and falling in the dark!



...illuminate the darkness

Stair stringer profile TWP45/3



Suitable for the following types of flooring

- Side finish for stairs

Product information

- Made of Polyblend based on ABS
- Provides a perfect cover for stair stringers

Processing recommendations



Döllken
Skirting
scissors



Döllken
Mitre Shears

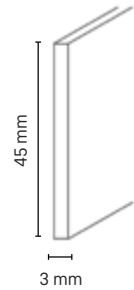

All sales channels

- 1 sales unit = 20 x 2,5 m

Colours



1230
white

Stair mat angle

Also
available
as self-adhesive
version upon
request!

Passend zu folgenden Belagstypen

- For the protection of stair treads

Product information

- Made of rigid PVC, ideal for carpet stair mats
- The stair mat angle gives shape to the flooring and provides grip at the edge
- Profiles are glued onto the back of the floor covering

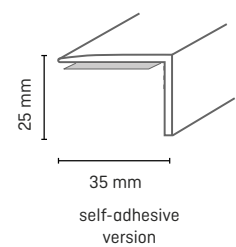
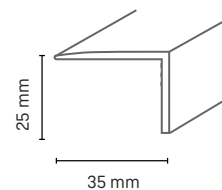

All sales channels

- 1 sales unit = 100 x 0,63 m

Colours



uni

Edge strip SK

self-adhesive

Suitable for the following types of flooring

- PVC and carpet floors with a material thickness of 3-5 mm

Product information

- Flexible adjustment thanks to elastic soft lip
- Covers rough cut edges
- Elastic plastic - easy to cut with a carpet knife or suitable scissors
- Easy to install without tools thanks to self-adhesive coating on the underside
- Self-adhesive
- Retail packaging with assembly instructions

Processing recommendations



Döllken
Skirting scissors



Döllken
Mitre Shears

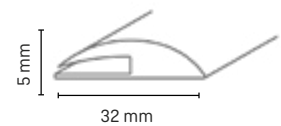

All sales channels

- 1 sales unit = 10 x 1 m

Colours



grey



black

Double edge strip SK

self-
adhesive

Suitable for the following types of flooring

- PVC and carpet floors

Product information

- Flexible adjustment thanks to elastic soft lip
- Covers rough cut edges
- Easy to cut with a carpet knife or suitable scissors
- Easy to install without tools thanks to self-adhesive coating on the underside
- Elastic plastic
- Retail packaging with assembly instructions

Processing recommendations



Döllken
Skirting scissors



Döllken
Mitre Shears

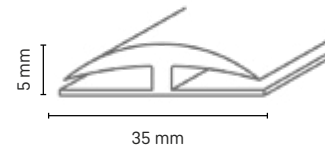

All sales channels

- 1 sales unit = 10 x 1 m

Colours



brown beige



brown



grey



black

Plastic transition profile



Product information

- Robust transition strip made of extra hard plastic
- Can be cut with a fine-tooth saw
- Easy to install by screwing on with the supplied screws and dowels
- Covers rough cut edges of the floor coverings and provides permanent protection at the transition
- Flexibility in design due to a wide range of colours
- Retail packaging with assembly instructions, including dowels and colour-coordinated screws

Processing recommendations



Döllken Skirting scissors



Döllken Mitre Shears

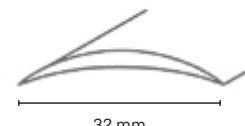

32 mm

All sales channels

- SB: 1 sales unit = 10 x 1 m

Colours



grey beige



grey



brown



black

Transition profile SK



self-adhesive

Product information

- Flexible adjustment due to elastic soft lip for PVC and carpet floors with a material thickness of 3-5 mm
- Covers rough cut edges of the floor coverings
- Easy to cut with a carpet knife or suitable scissors thanks to elastic plastic
- Easy installation: Self-adhesive coating on the underside
- Retail packaging with assembly instructions

Processing recommendations



Döllken Skirting scissors



Döllken Mitre Shears

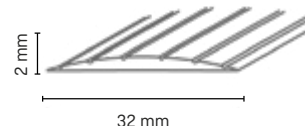

2 mm

32 mm

All sales channels

- 1 sales unit = 10 x 1 m

Colours



grey



brown beige



brown

Tools –
professionally crafted
and securely fastened

Döllken Profiles
SURTECO GROUP



With our specialists from Team Döllken, you can easily master big challenges

The tools from Döllken Profiles are unique and offer various features and benefits, including:

- high work speed during installation
- flawless results in terms of quality
- a comprehensive range of proven system tools
- the hot-melt adhesive fastening system for quick, clean, and secure installation

Tool overview

	Page
Mitre Tool Typ 2001	118
Mitre Tool Accessories: Clamping Lever-XL and Pressing inserts	119
Mitre Tool Accessories: Trestles	119
Toolbox Sets	120
Hot-melt adhesive system	122
Adjustable LVT-Strip Cutter	124
Replacement Blades for LVT-Strip Cutter	124
Notching Pliers	125
Special Marker for Skirting Board Installation	126
Dry Adhesive Tapes	126
Easy-Scooter	128
Assembly-Hammer	128
Skirting scissors	129
Mitre Shears	129
Flooring Set	130
Tapping Block for laying parquet	131
Pull Bar for laying parquet	131
Wooden Wedges for laying parquet	132
Ridged Plastic Wedges	132
Tensioning Strap for laying parquet	133

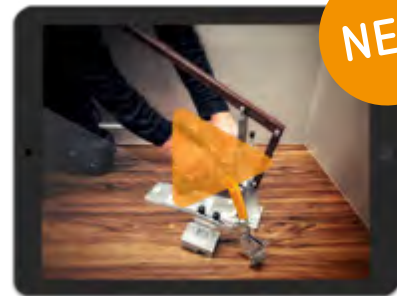

Subscribe to the channel now and never miss a video again!

Mitre tool type 2001

for all Döllken solidcore skirting boards



All skirting boards suitable for use with the mitre tool are marked with this icon.

Product information

- For punching all Döllken solidcore skirting boards
- Easy and efficient punching of seamless, closed external and internal corners, as well as end caps
- With a simple switch or upgrade to the clamping lever XL*, it is also suitable for solidcore skirting boards with a 16mm core [Cubu flex life XL, Cubu XL Touch & Style, and Hamburg Style]
- Easy determination of punching point with the newly developed measuring template
- Accessories such as punch case and pressing inserts for punching design flooring strips are also available, specifically for the solidcore skirting boards D 60 or C 60

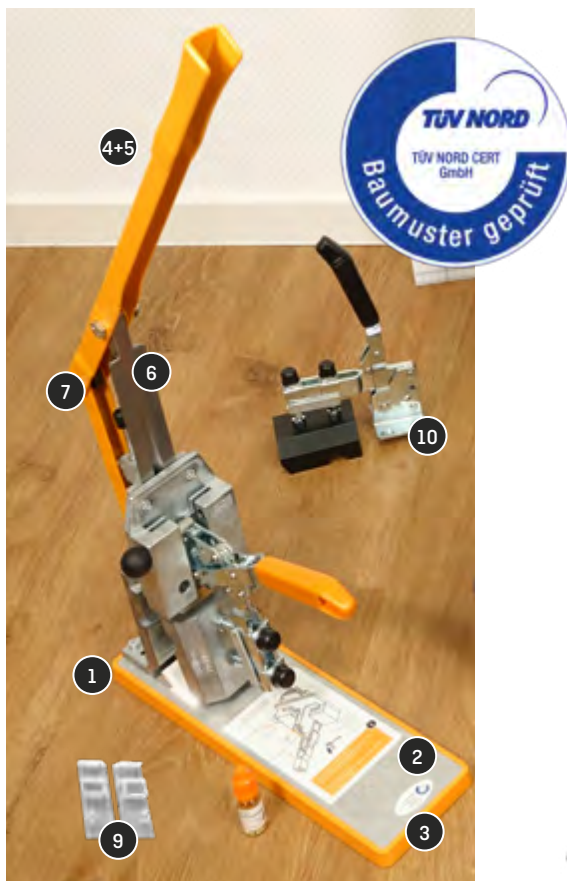

No.	Döllken Mitre Tool Parts	Item no.
1	Mitre Tool Type 2001	5112900
2	Base plate for Mitre Tool Type 2001	5106890
3	Protective cover	5116321
4+5	Handle with spring for Mitre Tool Type 2001	5106894
6	Spare blade for Mitre Tool Type 2001	5112706
7	Spare spring for Mitre Tool Type 2001	5106897
8	Measuring template for Mitre Tool Type 2001	5116558
9	Mitre tool-Pressing inserts for design flooring	5105434
10	Clamping Lever-XL für Mitre Tool Type 2001	5111423
11	Toolcase (only for Mitre Tool) (empty)	5903192



Even easier installation with the new measuring template

- The mitre tool is available individually in a matching case, including the measuring template, or in tool case sets!
- Parts of the mitre tool can be reordered individually

Mitre Tool Accessories: Clamping Lever XL and Pressing Inserts



All skirting boards suitable for use with the clamping lever XL are marked with this icon..



Pressing Inserts for design flooring



Pressing Inserts for the HSL (page 46)

Product information

Clamping Lever XL

- for precise cutting edges – fast and clean
- ideal for skirting boards with a 16 mm thick core for extra-large overlap
- black lever: Cubu XL, Cubu XL Touch & Style, Hamburg Style series

Pressing Inserts

- before using the pressing Inserts to punch design coverings with soft backs, suitability must be tested beforehand
- by punching the covering strips using the pressing Inserts, the strips can be easily glued into the profiles without tension



Mitre Tool Accessories: Trestles



Product information

- for optimal support of the skirting boards during punching with the mitre tool
- suitable for the following solidcore skirting boards: EP flex life, Cubu flex life, Cubu flex life XL, Cubu XL Touch & Style, Cubu flex life Premium, Cubu Stone & Style, Cubu Touch & Style, Hamburg Style
- profiles with a 5 mm core can be cut without the use of trestles
- also available for retrofitting.



Mitre tool type 2001 with protective cover

Toolbox Sets



Mitre Tool Set –

Compact and well-organized!

Now with the new special marker for skirting boards!

Product information

- The sturdy and stable toolbox can hold all system tools at once - everything is easily accessible and securely stored with just one grip
- Compatible with many popular device cases/ system cases for drills, cordless screwdrivers, etc., and can be connected as a suitcase system, stacked, or moved with a transport trolley
- Available empty or in 3 different options (with tools)
- Comprehensive accessories for measuring, punching, cutting, and gluing all Döllken solidcore skirting boards
- The newly developed measuring template makes it even easier to determine the punching points
- All components are also available individually and are listed in the table next to this text



Scan now and see our tools in action: [youtube.com/DöllkenProfilesGmbH](https://www.youtube.com/DöllkenProfilesGmbH)

No.	Designation	Item no.
1	Mitre Tool Typ 2001	5112900
2	Measuring template for Mitre Tool Typ 2001	5116558
3	Systainer Toolbox set (empty)	5905625
4	Mitre Tool-Pressing inserts for design flooring	5105434
5	Clamping Lever-XL for Mitre Tool Type 2001	5111423
6	Adjustable LVT-Strip Cutter	5120310
7	Hot-melt adhesive gun 2.0 E with case	5119732
8	Skirting scissors	5105419
9	Hot-melt adhesive sticks (transparent)	
	• 1 sales unit: 1 Plastic bucket 5 kg (66 Sticks) • 1 sales unit: 5 foil bags of 2 kg (27 Sticks) = 10 kg	5105424 5105422
	Small Toolbox set	5112465
	Large Toolbox set with HKP 220	5112425
	Large Toolbox set with HKP 2.0 E	5120647
	Inlay Toolbox set for HKP 220	5120010
10	Inlay Toolbox set for HKP 2.0 E	5120203

The toolbox set is available in three variations:

1 SMALL TOOLBOX SET

consisting of:

- ✓ Mitre tool
- ✓ Protective cover (mounted)
- ✓ Tool case
- ✓ Carrying strap
- ✓ Skirting scissors
- ✓ Pressing Inserts
- ✓ Trestles
- ✓ Measuring template
- ✓ Clamping lever XL
- ✓ Oil bottle
- ✓ Folding ruler
- ✓ Special marker for skirting boards

Item no.: 5112465



2 LARGE TOOLBOX SET WITH HKP 220

consisting of:

- ✓ small toolbox set
- + Hot-melt adhesive gun HKP 220
- + 10 hot-melt adhesive sticks (transparent)
- + new adjustable LVT strip cutter (including spare blades)

Item no.: 5112425

Now comes standard with an adjustable LVT strip cutter



3 LARGE TOOLBOX SET WITH HKP 2.0 E

consisting of:

- ✓ small toolbox set
- + new Hot-melt adhesive gun HKP 2.0 E
- + 10 hot-melt adhesive sticks (transparent)
- + new adjustable LVT strip cutter (including spare blades)

Item no.: 5120647



Hot-melt adhesive system



LED status display



HKP 2.0 E



Product information

- For professional, fast, and precise bonding of solidcore skirting and system skirting with Döllken Profiles hot-melt adhesive HKS 18/300

Consists of

- Hot-melt adhesive gun HKP 220 or new HKP 2.0 E including case, angled nozzle, and 4.2m cable
- Hot-melt adhesive HKS 18/300 (transparent) for processing with hot-melt adhesive gun HKP 220 or new HKP 2.0 E



HKP 220
Item no.:
5105420

Features of the new HKP 2.0 E



- ✓ Smart working with the highest precision through specially developed electronic feed of the adhesive sticks
- ✓ Two switchable power levels for regulating the amount of adhesive
- ✓ Significantly faster processing (no pumping, maximum throughput time)
- ✓ Automatic adjustment after the bonding is finished
- ✓ LED status display with temperature control

All skirting boards to be processed with the hot-melt adhesive are marked with this icon.



Spare parts for hot-melt adhesive guns
HKP 220 & HKP 2.0 E:



Replacement nozzle
Item no. 5105884



Unbeatable Team



Bucket conveniently refillable with the purchasable foil bags

Hot-melt adhesive
HKS 18/300 transparent
Item no.: 5105424

Hot-melt adhesive gun
HKP 2.0 E
Item no.: 5119732

What sets the Döllken hot-melt adhesive sticks apart from other adhesive sticks:

- ✓ Stick diameter is 100% accurate (deviating diameters can damage the gun)
- ✓ High-quality raw materials ensure consistent bonding quality
- ✓ Other sticks have, among other things, a longer open time and prevent fast and efficient work / Döllken sticks have an open time of about 30 seconds
- ✓ Adhesive sticks are REACH certified
- ✓ Adhesive sticks are made in the EU with controlled and certified supply chain

Important information

Only use the Döllken hot-melt adhesive guns with the corresponding hot-melt adhesive!

Scan now and see HKP in action:



Bezeichnung	Item no.
Hot-melt adhesive gun 2.0 E with case	5119732
Hot-melt adhesive gun 220 with case	5105420
Hot-melt adhesive sticks HKS 18/300 (transparent)	
• 1 sales unit: 1 Plastic bucket 5 kg (66 Sticks)	5105424
• 1 sales unit: 5 foil bags with 2 kg (27 Sticks) = 10 kg	5105422
• Replacement nozzle	5105884

Why should you only use Döllken hot-melt adhesive?

Failure to do so may result in damage or even total failure of the hot-melt adhesive gun. Adhesives from other manufacturers have a different composition and melting points, which can cause them to enter the feed chamber and completely clog the mechanism. In addition, processing may be impaired, as foreign adhesives do not exhibit the same adhesive properties and may drip heavily during processing.

When using hot-melt sticks from other manufacturers, you will forfeit all warranty claims. You can recognize the Döllken adhesive stick by the UV stripe in the center of the transparent sticks.

All of our adhesive sticks are sold under the name Döllken.

Adjustable LVT Strip Cutter



Simple and accurate adjustment



Product information

- Suitable for cutting design flooring strips for various Döllken profiles (corresponding marking on the strip cutter available)
- Easy adjustment with just a few manual steps from 38 to 140 mm width
- Secure fixation of the set width
- Suitable for cutting design flooring strips for solidcore skirtings D 60, C 60 and C 100
- Included in the large toolbox set (in combination with the new HKP 2.0) or available separately
- Item no.: 5120310



All skirting boards to be processed with the strip cutter are marked with this icon.



NEW:

Included in both large toolbox sets.
Also available separately!

Replacement Blades for LVT Strip Cutter

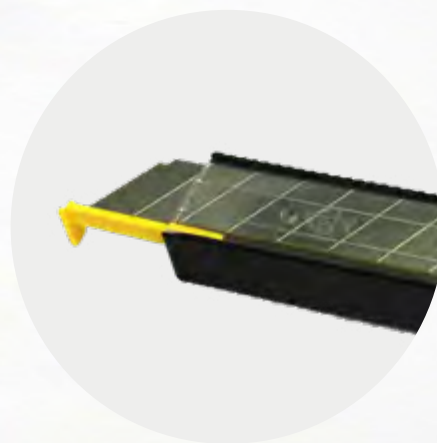
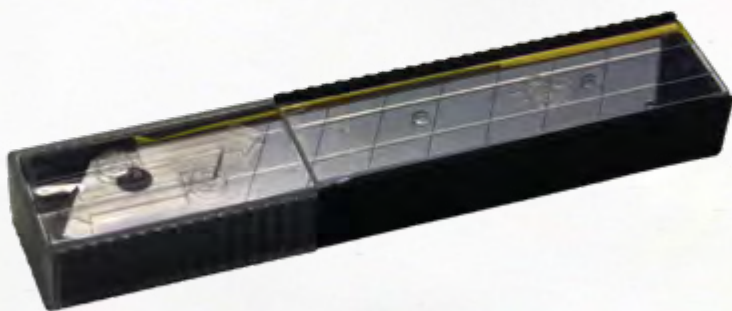

Product information

- Blade grinding and an additional coating increase the lifespan and enable stable and precise cutting
- Practical safety dispenser to always have the blade reserve on site - safe and easy removal
- 1 sales unit (sales unit) is included in the large toolbox set
- 1 sales unit = 70 breakable blades
- Item no.: 5901530



Scan now and watch the
strip cutter in action:



Notching Pliers



With the notching pliers, cable outlets can be cut out super quickly, for example, for the new Cubica Light System 80 light strip.

Product information

- for notching cutouts in plastic profiles "cable outlets", e.g.: base profiles Cubica LS and GP 20, S 60 flex life / S 100 flex life / KSO / TS 60 C 60 / D 60, C 100, HSL 6/8/10, USL 60
- also suitable for notching cutouts in plastic housings for electrical and plumbing installation
- for cutting out recesses in adhesive-LVT or other flooring for heating pipes
- clean cutting edges, precise cutting of the flexible soft lips on the skirting board
- good handling, pliers open automatically
- ergonomic handle for excellent comfort and control during use
- Item no.: 5124984

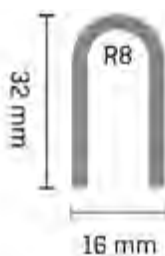

- Cutting width: 16 mm
- Cutting depth: 32 mm
- Length: 190 mm
- Weight 460 g



Notching leave outs heating pipes



Notching LVT, flooring coverings



Notching cable outlets



All skirting boards that can be processed with the notching pliers are marked with this icon.

Special Marker for Skirting Board Installation



Product information

- Dry-wipeable
- Line width: 1 mm
- Colour: black
- applicable on plastic
- 1 marker included in all toolboxes sets (replaces pencil)
- 1 sales unit: 25 pieces
- Item no.: 5125238



Also available in a counter display with 25 special markers!



Dry-wipeable on the skirting board



Dry Adhesive Tapes



Scan now and see dry adhesive tapes in action:



Dry adhesive tapes are not part of Döllken's product range, please ask your wholesaler.



Product information

- For fastening a variety of our skirting boards, we recommend using mounting tapes (Toptac 35, Remur, Pomur and Contact 40) from UZIN
- The installation products of this company are perfectly matched to the installation of Döllken skirting boards. This guarantees a secure and craftsman-friendly installation.



All skirting boards that can be fastened with UZIN mounting tapes are marked with this icon.

Floorboard



Product information

- Ideal for laying floors and tiles, grouting, and painting
- FLOORBOARD, the indestructible knee roller, is a must-have for any professional who works while kneeling
- Even after hours, working without fatigue is still possible

Why do I need a Floorboard?

- Protects knees and back
- Versatile and offers optimal mobility
- Highly stable construction

Technical Specifications:

- Size: 57 x 33 x 9 cm (L x W x H)
- Load capacity: up to 150 kg
- Weight: approx. 4 kg



Additional uses:

- Surface for holding containers: 30 x 40 cm (L x W)
- Recess for mixing buckets up to 31.5 cm in diameter

- Item no.: 5112265

Replacement parts for the Floorboard:

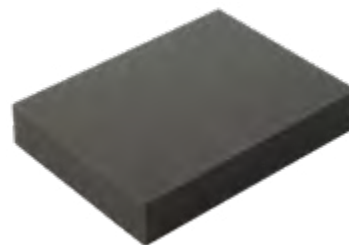

Foam cushion
Item no.: 5113929



Replacement rollers
Item no.: 5113928

i

For repairs to the tools, please contact your wholesaler or specialist retailer!

Easy-Scooter



i

The Easy-Scooter is delivered without tools and soft strips! You can find the skirting scissors and the assembly hammer below and on page 129, the flexible soft skirting boards from page 90.

Product information

- Dispensing device for fast and precise installation of soft skirting boards
- Indispensable for every installer of soft skirting boards
- Item no.: 5114160

Why do I need a dispenser for soft skirting boards:

- Effortless, fast, and even dispensing of the soft skirting board from the roll
- Versatile and optimal mobility
- Fastening possibility for installation tools (rubber hammer/skirting scissors)
- Highly stable construction



All skirting boards that can be processed with the Easy-Scooter are marked with this icon.

Technical data:

- Size: \varnothing 50 cm
- Load capacity: up to 50 kg
- Weight: approx. 5 kg (without soft skirting board roll and tools)



Additional uses:

- Dispensing of edge insulation strips, cables, wires, etc.

Assembly Hammer



Product information

- Practical rubber hammer for tapping skirting boards into place
- Tapping during installation of the profiles builds up the necessary adhesive force
- Robust design (professional quality)
- White head with small diameter does not leave black marks on the profiles or on the floor

- The assembly hammer is available individually.
- Item no.: 5112806



All profiles to be processed with the assembly hammer are marked with this icon.

Skirting Scissors



Blade is also available as a spare part:
Item no. 5105881

Product information

- For precise cutting of profiles and skirting boards
- Cutting length: 80 mm
- Robust and durable thanks to carbon steel blade
- Precise cuts without requiring high force
- Engraved markings in millimeters/inches
- Item no.: 5105419



All profiles to be processed with the skirting scissors are marked with this icon.

Mitre Shears



NEW

Product information

- For 45° cuts of profiles and skirting boards
- Specifically designed for cutting mitre cuts of profiles and strips up to a maximum cutting length of 80 mm, among others for plastic profiles, transition strips, expansion joint profiles, tile edge trims, flat wooden strips, quarter-rounds, fillet skirting boards, decorative trims
- Engraved markings in millimeters/inches
- Precise cuts without requiring high force
- Item no.: 5126064



All profiles to be processed with mitre shears are marked with this icon.

Blade is also available as a spare part:
Item no. 5105881

Flooring Set



Product information

- Pull bar
- Tapping block
- 24 plastic wedges.

All sales channels

- 1 sales unit = 6 pieces (SB-packed)

Tapping Block for laying parquet



Product information

- Length: 30 cm

All sales channels

- 1 sales unit = 12 pieces (SB-packed)

Pull Bar for laying parquet



Product information

- Length: 30 cm

All sales channels

- 1 sales unit = 6 pieces (SB-packed)

Wooden Wedges for laying parquet



Product information

- 12 pieces
- with assembly instructions

All sales channels

- 1 sales unit = 10 pieces (SB-packed)

Ridged Plastic Wedges



Product information

- 30 pieces in a box

All sales channels

- 1 sales unit = 10 x 30 pieces (SB-packed)

Tensioning Strap for laying parquet

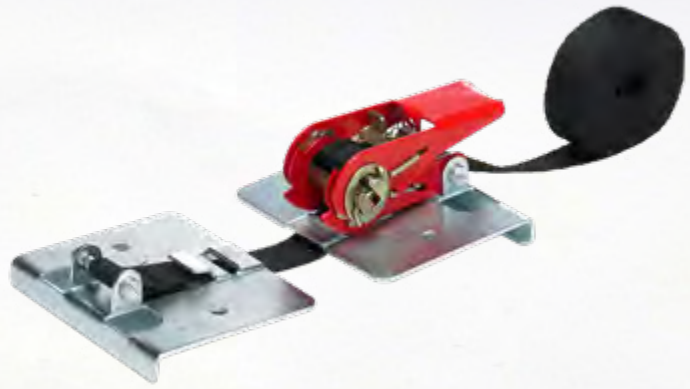

Product information

- Strap length: 5 m

All sales channels

- 1 sales unit = 5 pieces (SB-packed)



Kitchen Profiles

The clean connection between countertop and wall

Döllken Profiles kitchen profiles are unique and offer various features and benefits:

- Matching decors for numerous countertops
- Useful and coordinated accessories
- Various geometries and designs

Overview of kitchen profiles

(Wholesale | All sales channels)

Wall joint trim Design	136
Wall joint trim Classic	137
U-Profil for Kitchen Plinth	138
Ventilation Grille	138
Worktop End Profile	139
Connection Profile	139
Worktop Connectors	140
Universal Connection Profile – Square	140
Corner connection profile	141
Damp-Proof Barrier	141
Multifunctional Profile Top Line	142

Wall joint trim Design

Self-Adhesive
and screwable



- Especially suitable for use in kitchens

Processing recommendations

Product information

- Transparent, elastic sealing lip for covering gaps and joints
- Double-sided self-adhesive strips and drill holes on the base profile for easy installation
- Rotate the profile by 90° for a larger overlap of 24 mm

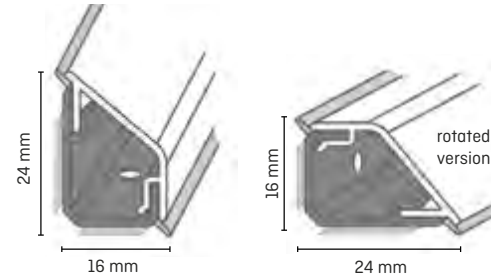

All sales channels

- 1 sales unit = 6 x 3,0 m
(also available in 0.6 m)

Matching decor
edge banding
(640 x 44 mm)
available on request!



Accessories

SB Inside corner, Outside corner: 1 sales unit = 5 x 1 piece
SB End caps: 1 sales unit = 5 x 2 pieces



Inside corner Outside corner End caps left & right

Colour selection

0117 white	1020 sand	1087 brown	1090 grey
1063 silver	1085 beige	1010 dark brown	1091 chocolatebrown
1084 gold	1086 light brown	1089 gelbbeige	1022 black

Accessories for the rotated
version are available on request!



Colours

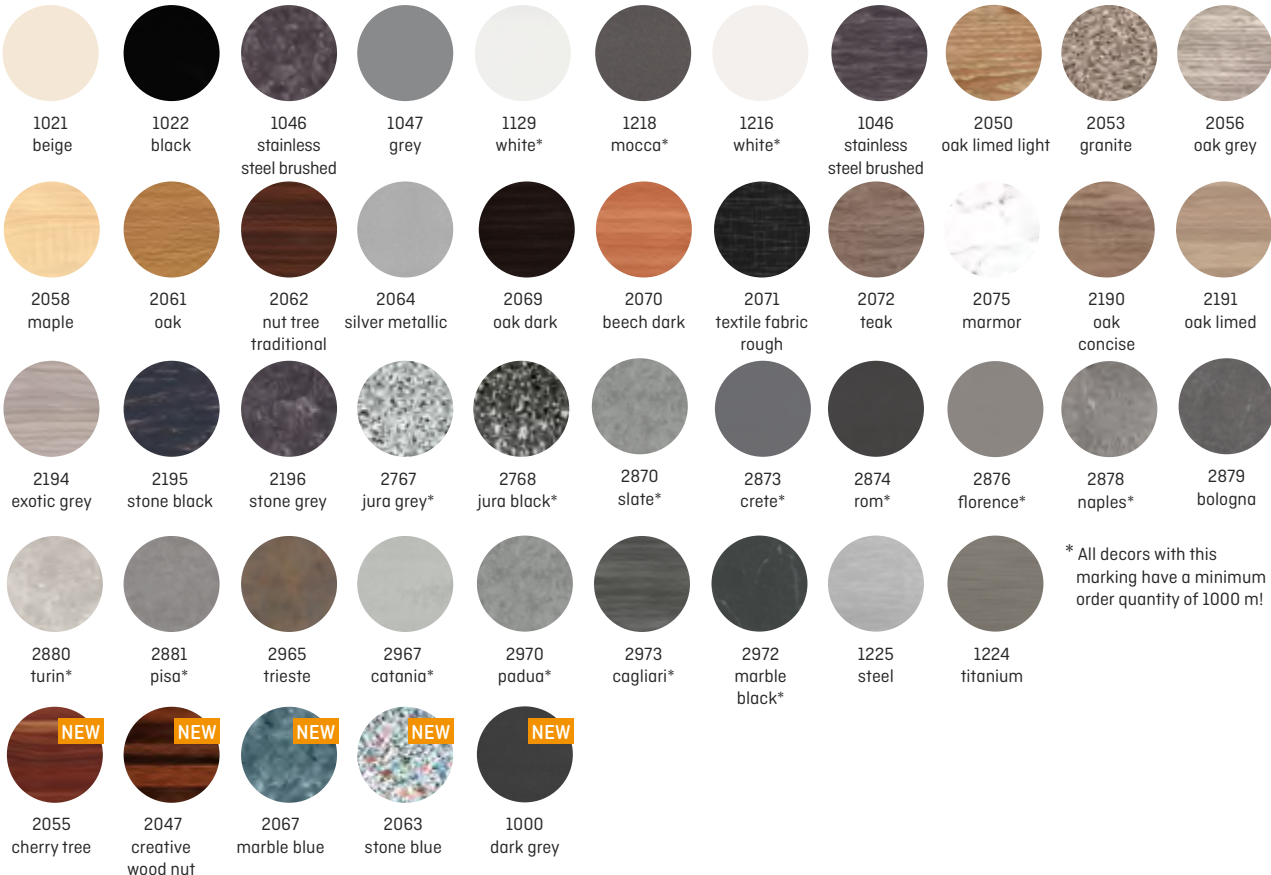

Wall joint trim Classic



- Especially suitable for use in kitchens

Product information

- Optimal protection against moisture penetration
- Fully high-quality surface directly printed including sealing lips
- Colour-coordinated (solid colours) corners and end caps
- Available for all common countertops
- Two-part: consisting of base profile (for screwing to the wall and countertop) and cover profile

Processing recommendations



Skirting scissors



Screws



Mitre Saw

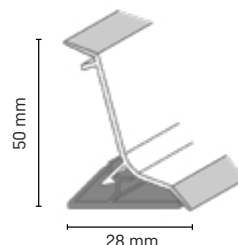

All sales channels

- 1 sales unit = 10 x 3,0 m

Accessories

- Available as a set
- SB: accessory set consisting of
- 2 x inside corner (2 pieces), outside corner (1 piece) and end caps (1 pair)



Inside corner
90°
2 pieces,
plastic
SB-packed



Outside corner
90°
1 piece,
plastic
SB-packed



End caps
1 Paar, plastic
SB-packed

Colour selection
white
grey
jura grey
beech

Colours



white



silver grey



sardogranite



beech

U-Profile for Kitchen Plinth



Product information

- Plastic
- With soft lip for optimal protection against moisture and dirt
- For kitchen panels
- Available in 16 mm and 19 mm

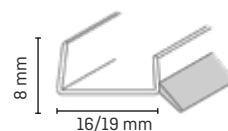

All sales channels

- 1 sales unit = 20 x 2,5 m

Colours

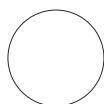

transparent

Ventilation Grille



Product information

- Anodized aluminum
- For optimal air circulation under kitchen worktops and panels or on doors
- Easy to remove for cleaning due to plug-in mounting
- Packed in SB with assembly instructions

Maße

- 500 x 70 mm (outer dimensions)
- 475 x 58 mm (inner dimensions)

All sales channels

- 1 sales unit = 4 x 1 piece

Colours



silver

Worktop End Profile



Product information

- Anodized aluminum
- Elegant finish for worktops
- Self-assembly pack with installation instructions

All sales channels

- 1 sales unit = 4 x 1 piece

Colours



silver

Dimensions

- Available upon request!
- Length: available in 0.60 or 0.635 m



Connecting Profile

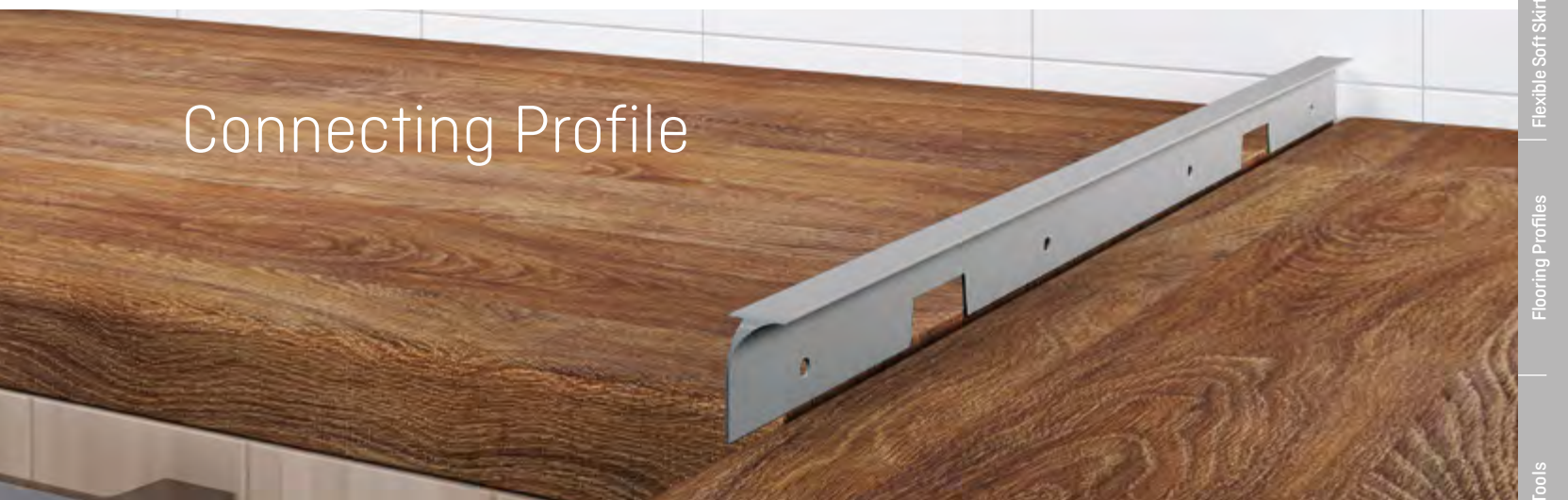

Product information

- Anodized aluminum
- Self-assembly pack with installation instructions

All sales channels

- 1 sales unit = 5 x 1 piece

Colours



silver

Corner Connectors Westag

- Thickness: 38 mm
- Length: 0.6 m



Corner Connectors Hornitex / Resopal

- Thickness: 38 mm
- Length: 0.6 m



Corner Connecting Profile

- Available on request!
- Thickness: 38 mm
- Length: available in 0.6 m or 0.635 m



Worktop Connectors



Product information

- Available in lengths of 150 mm and 70 mm
- For corner and longitudinal connections
- Pack of 2

All sales channels

- 1 sales unit = 10 x 1 piece

Universal Connecting Profile - Square

Product information

- Anodized aluminum
- For round worktops (thickness: 38 mm)
- Self-assembly pack with installation instructions

All sales channels

- SB: 1 sales unit = 5 x 1 piece

Colours



alu

Shape A

- Available upon request!
- Thickness: 38 mm
- Length: available in 0.6 m and 0.635 m



Shape B

- Thickness: 38 mm
- Length: 0.6 m



Corner connection profile

Product information

- Specifically designed for Resopal worktops

All sales channels

- 1 sales unit = 5 pieces

Colours



alu

Damp-Proof Barrier

Product information

- Aluminum adhesive foil for protecting the underside of worktops in the vicinity of ovens and dishwashers
- Effectively prevents worktop swelling caused by dishwasher or oven steam
- Self-adhesive

All sales channels

- SB: 1 sales unit = 1 piece

Dimensions

- Width: 7.5 cm
- Length: 1.0 m

Colours



aluminium

Multifunctional Profile Top Line

With the appropriate accessory part (inside corner), it is possible to cover horizontal and vertical joints.



Product information

- Versatile use: perfect as a wall connection profile in the kitchen and bathroom, or for covering horizontal and vertical joints between furniture
- Enhanced with a modern genuine metal foil
- Self-adhesive for easy installation
- Clean finish with flexible soft lips that adapt to the wall and countertop
- Durable surfaces provide a long lifespan, are abrasion-resistant and resistant to household cleaning agents
- [Base profile] Made from a chlorine-free polyblend based on ABS with flexible soft lips made from a thermoplastic elastomer (TPE) to adapt to the wall and countertop
- [Cover profile] Made from a chlorine-free polyblend based on ABS, covered with a genuine metal foil

Processing recommendations



Mitre Saw

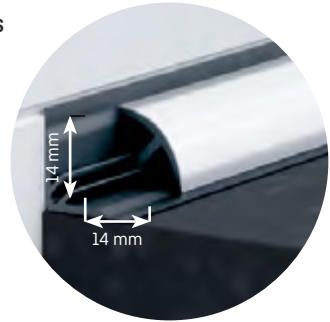

All sales channels

- 1 sales unit = 10 x 2,50 m
- 1 sales unit = 10 x 5,00 m (only decor 1046 stainless steel brushed is in stock, other colours are produced on demand)

Colours



Accessory sets

- SB: 1 sales unit = 10 pieces, consisting of inside corners (4 x 90°, 2 x 135°), outside corners (2 pieces) and end caps (left and right 2 pairs)



Accessories

- Inside corner (90°): 1 sales unit = 10 x 10 pieces
- Inside corner (135°): 1 sales unit = 10 x 10 pieces



- Outside corner: 1 sales unit = 10 x 10 pieces
- End caps: 1 sales unit = 10 x 10 pieces



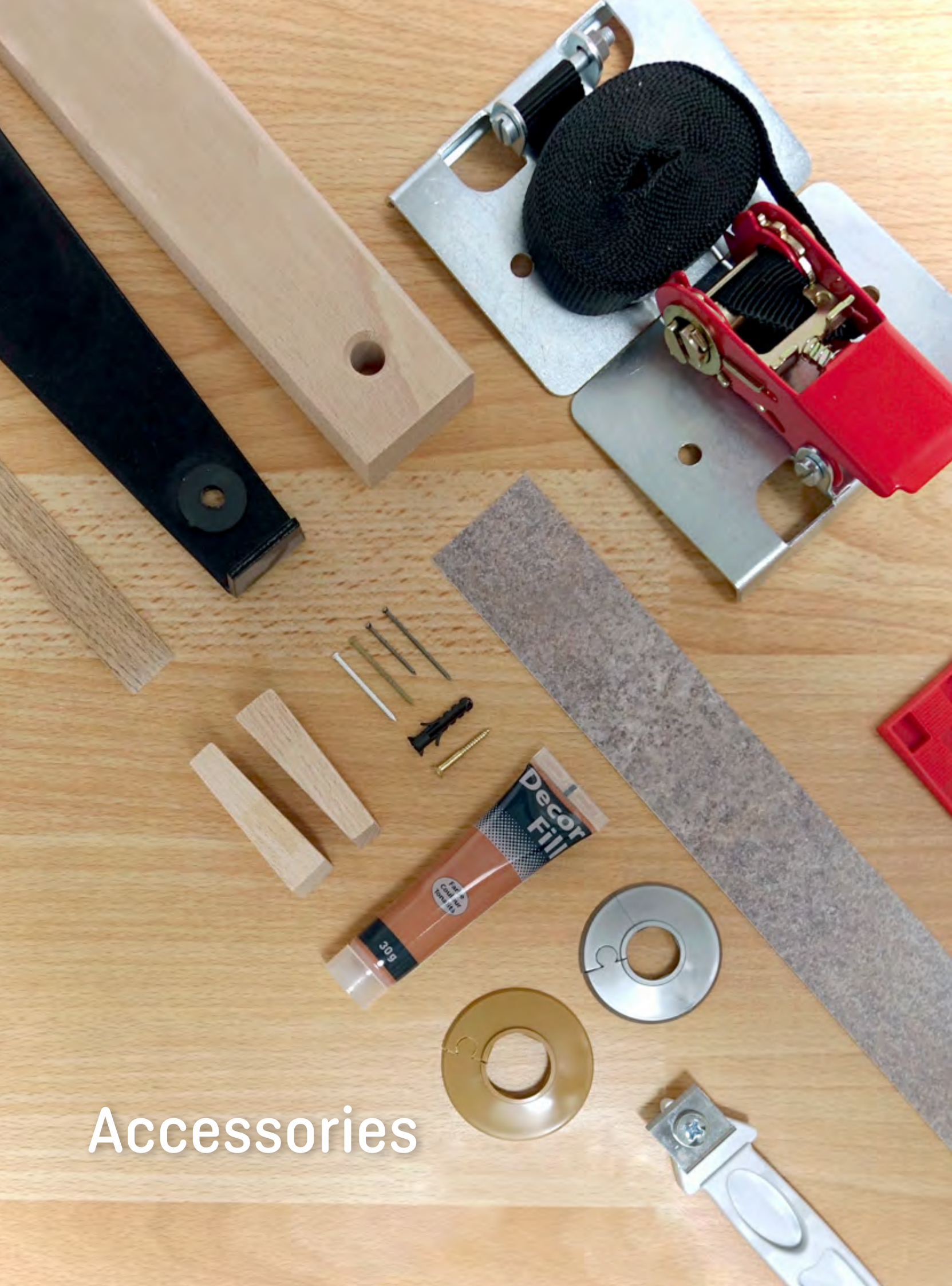

Accessories

Useful helpers and all-rounders for daily use

Overview Accessoriess

(All sales channels)

Fugenfill Set	146
Fugenfill-Tube or Cartridge	146
Fugenfill-Cleaner	146
Decor-Fill	147
Anti-Slip Mat	148
Anti-Slip Fleece	148
Edge Banding	149
Edge Trimmer for Enge Banding	149
Soft Edge	150
Panel intermediate and end profile	151
Pipe Collar	151
Steel pins	152
Screws & Dowels	152
Skirting Board Pins	152
Clamping dowels and Fitschen pins	152
ClipStar Metal Type G	153
Mounting Clip C	153

Close profile joints and gaps easily with Fugenfill.

- ✓ Colour stable
- ✓ Moisture resistant
- ✓ Paintable

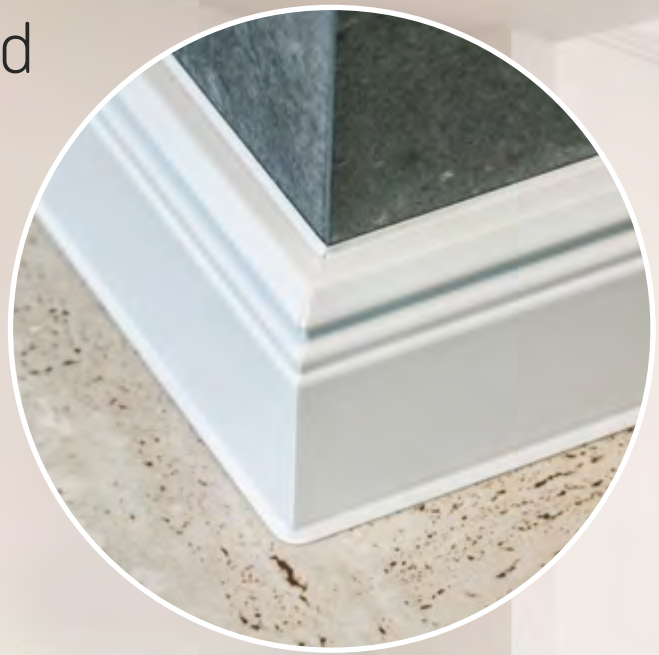

Simply scan and watch on YouTube!



Fugenfill Set



All skirting boards to be processed with the Fugenfill Set are marked with this icon.



Product information

- Perfects the installation of all white skirting boards – for joints and shadow gaps
- Easily close profile joints and gaps
- The pasty 1K filler can be easily applied from the outside and adapts to any gap
- Any excess filler can be easily smoothed with a spatula and removed with a cleaner
- Screw nozzles available as replacements upon request

Accessories

- Fugenfill
- Cleaner
- Screw nozzle
- Spatula
- Cotton cloth
- Felt sanding block

Description	Sales unit	Item no.
Fugenfill Set	1 x 1 piece	5115427
Fugenfill Screw nozzle	1 x 6 pieces	5116128
Fugenfill Cartridge 500g white	6 x 1 piece	5124423
Fugenfill Cleaner 250ml	12 x 1 piece	5124424
Fugenfill Tube white 150g	12 x 1 piece	5124422

Fugenfill-Tube or Cartridge



Product information

- Fugenfill available in a practical single tube (150g) or cartridge (500g)
- Tube (150g): 1 sales unit = 12 x 1 piece
- Cartridge (500g): 1 sales unit = 6 x 1 piece

Cleaner



Important note: The Fugenfill cleaner should only be used with solid colour skirting boards!



- Cleaner in a 250 ml bottle
- 1 sales unit = 12 pieces

Decor-Fill



Product information

- Tube, 30 g
- Retail-packed with instructions for use
- Repair paste for repairing minor damage to laminate floors

All sales channels

- 1 sales unit = 6 pieces (in one of the below listed colours, 1 tube contains 30 g, SB-packed)

Colours



maple



beech



oak light



natural oak



cherry
natural



oak dark

A photograph showing a square, light-colored mat with a grid of small circular holes placed on a dark wood-look parquet floor. The mat is partially overlapping a beige carpet. The text 'Anti-Slip Mat' is overlaid in white at the top left.

Anti-Slip Mat

Product information

- Carpet underlay suitable for all smooth and hard floors
- Non-slip grid surface
- Dimensionally stable and durable
- Hygienic and breathable
- Extends the life of the carpet by providing cushioning
- Washable up to 30°C
- Retail-packed

Dimensions

- Width: 0.60 m
- Length: 1.30 m

- Width: 0.80 m
- Length: 1.50 m

All sales channels

- 1 sales unit = 1 pieces (SB-packed)

A photograph showing a square, light blue-grey mat with a soft, fibrous texture placed on a dark wood-look parquet floor. The mat is partially overlapping a beige carpet. The text 'Anti-Slip Fleece' is overlaid in white at the top left.

Anti-Slip Fleece

Product information

- Underlay for carpets, runners, and rugs on all textile floors (also suitable for hard floors)
- Slip-resistant
- Suitable for underfloor heating
- Easy to cut to size
- Washable up to 30°C
- Retail-packed

Dimensions

- Width: 0.80 m,
- Length: 1.50 m

All sales channels

- 1 sales unit = 1 piece (SB-packed)

Edge Banding



Product information

- Reliable coverage of cut edges
- Iron-on melamine resin edge banding
- Extensive standard range in stock, many other designs available for short-term delivery
- Retail-packed with installation instructions

All sales channels

- 1 sales unit= 10 x 5 m (in 20 mm width, other widths available upon request, retail-packed)

Colours



Edge Trimmer for Edge Banding



Product information

- Retail-packed with instructions for use

All sales channels

- 1 sales unit = 8 pieces (SB-packed)

Soft Edge



Product information

- Ideal for curved and straight edges on shelves, panels, doors, and furniture
- Conceals rough veneers or cut edges elegantly
- Easy installation with contact adhesive or hot-melt adhesive gun

Available in the following sizes:

- 16 mm
- 19 mm (only available in white)

All sales channels

- 1 sales unit = 10 x 1 piece (Länge: 2m, SB-packed)

Colours



white



black

Panel intermediate and end profile

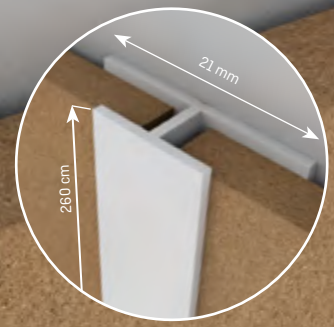

Product information

- Hard plastic
- Suitable for panel thicknesses up to 4.5 mm

All sales channels

- 1 sales unit = 10 x 2,6 m [SB-packed]

Colours



white

Pipe Collar

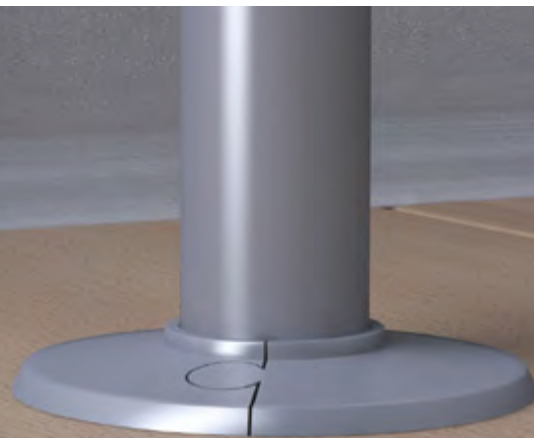

Product information

- Provides a harmonious finish for disturbing pipe transitions on the wall or on the floor
- Easy to assemble for a secure fit
- Permanent hold through additional fixation with adhesive
- Self-service packaged with assembly instructions

Available in the following sizes:

- 18 mm
- 22 mm

All sales channels

- 1 sales unit = 10 x 1 pieces [SB-packed]

Colours



white

Steel pins

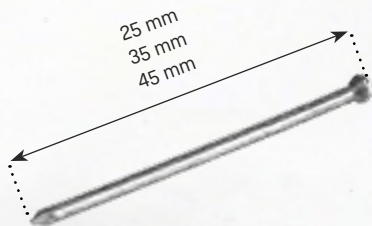

Product information

- For skirting boards
- Not galvanized
- Available lengths:
 - 25 mm, 35 mm, and 45 mm

All sales channels

- 1 sales unit = 20 x 100 pieces (SB-packed)



All skirting boards to be processed with the steel pins are marked with this icon.

Skirting Board Pins

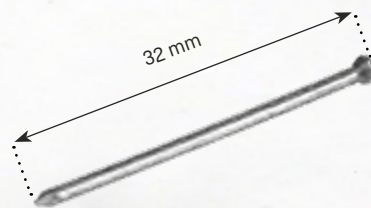

Product information

- Length: 32 mm

All sales channels

- 1 sales unit = 20 x 100 pieces (SB-packed)

Colours



white

maple/pine

oak/
cherry

nut tree/
mahogany

Screws & Dowels



Product information

- Available length (screws): 25 mm,
Diameter: 5 mm

All sales channels

- SB: 1 sales unit = 20 x 15 pieces (SB-packed)

Colours

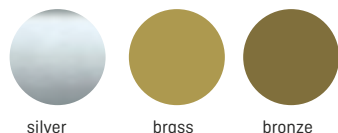

silver

brass

bronze

Clamping dowels and Fitschen pins



Product information

- Clamping dowels (black) for fastening clamping skirting boards KL60 (see page 67)
- Fitschen pins (galvanized) 1.5 x 35mm

All sales channels

- 1 sales unit = 250 pieces (Fitschen pins) (SB-packed)
- 1 sales unit = 100 pieces (Dowels) (SB-packed)

ClipStar Metal Type G



Product information

- Invisible attachment of skirting boards
- Attachment with screws and dowels
- Easy installation

All sales channels

- 1 sales unit = 10 packs include 50 pieces (SB-packed)
- 1 sales unit = 10 packs include 20 pieces (SB-packed)



All moldings to be processed with the ClipStar Metal Type G are marked with this icon.

Mounting Clip C



Product information

- Invisible attachment of skirting boards USL 50 and Foam Molding Classic 50
- Attachment with screws and dowels
- Easy installation

All sales channels

- 1 sales unit = 10 x 20 pieces (SB-packed)

Naturally sustainable!



The sustainable use of resources is very important to us. Therefore, an efficiency enhancement project is being implemented at the Grammetal location. The goal is to save energy by using modern LED lighting technology, optimizing compressed air, and recovering waste heat from machines, thereby significantly reducing CO₂ emissions. In the future, this will save approximately 96 tons of CO₂ per year. This project is financially supported by the European Regional Development Fund.

Certified Quality

- ISO 50001:2018 - Energy Management
- ISO 9001:2015 - Quality Management
- ISO 14001:2015 - Environmental Management Systems
- All materials used are REACH-compliant.
- All solidcore skirting boards are made of chlorine-free plastic, they are certified low-emission according to ISO 16000, and the HDF cores are FSC-certified. Use of PVC without harmful heavy metals.

Responsibility for a shared future

As a globally recognized manufacturer of high-quality plastic skirting boards, we are committed to excellent and sustainable quality. We continuously test all common products with regard to their composition, processing quality, and environmental compatibility. Whether it is the choice of raw materials or the optimization of production processes: Environmental friendliness is a top priority for us. Even after the installation of our skirting boards, our responsibility for sustainability is far from over. That's why we rely on certifications and constant quality control - for a healthy living environment and ecological compatibility.



In our solid wood catalog, you will find our FSC and PEFC certified wooden skirting boards!



Almost all products are Greenguard Gold certified. This means that they meet the strictest requirements for reducing emissions of pollutants into the indoor air.

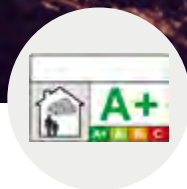

All solidcore skirting boards are made of chlorine-free plastic, they are certified according to ISO 16000 and are low-emission.



A large number of our plastic skirting boards (including stair edges, soft strips) are produced exclusively with phthalate-free plasticizers.



Almost all solidcore and soft skirting boards of the "Life" series are awarded the Blue Angel certification.

You can find all article numbers
for the products online!

Just scan the QR code >>



**All article numbers
to the products**



Important changes in the assortment and the latest online version of the catalogue you will always find on our website doellken-profiles.com

Head office

Döllken Profiles GmbH
Industriestraße 1
59199 Bönen
T: +49 3643 4170 711
F: +49 3643 4170 330
info@doellken-profiles.com
www.doellken-profiles.com
Follow us:   

Döllken CZ s.r.o.
K Hájem 1233/2
155 00 Praha 5
T: +420 251 627 298
F: +420 251 627 295
info.cz@doellken-profiles.com
www.doellken.cz

Doellken Sp.z o.o.
ul. K.K.Baczyńskiego 25e
Sosnowiec 41-203
Polska
T.: +48 32 781 20 90
F.: +48 32 781 20 91
www.doellken.pl